

WOLFIN[®]

BAUTECHNIK

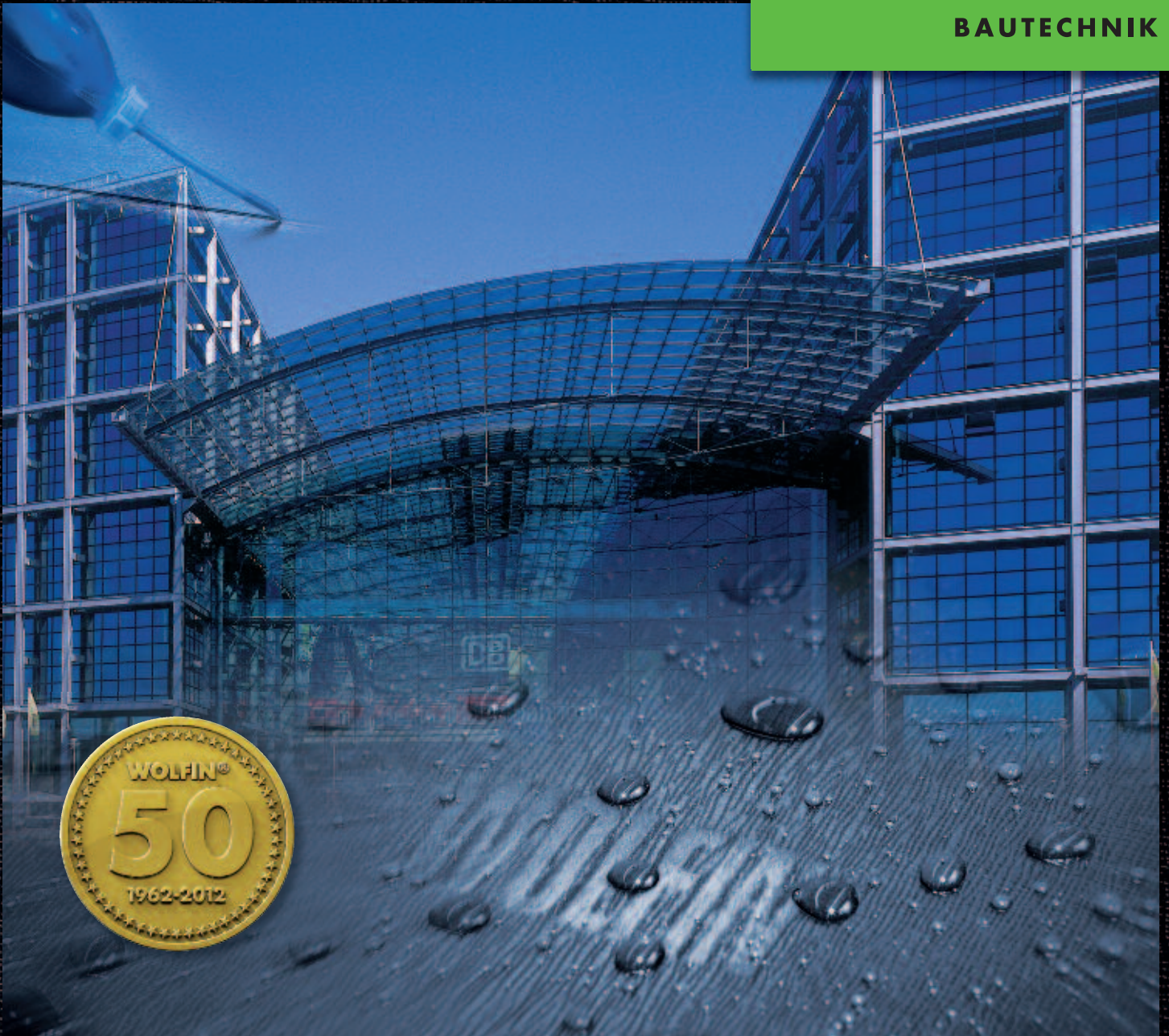

WOLFIN Waterproofing Systems

Designed to meet the highest demands
for buildings and flat roofs

WOLFIN[®] WATERPROOFING THAT WORKS.

Allianz Arena, Munich



Olympic Ski Jump, Garmisch-Partenkirchen



Photo: terrain: loenhardt&mayr_Landschaftsarchitektur



Riedberg School, Frankfurt



WOLFEN – Your expert and innovative partner for all waterproofing projects

For more than five decades WOLFEN has counted among the leading European manufacturers of waterproofing systems for flat roofs and buildings. WOLFEN membranes cover millions of square metres in all climatic zones of our planet. Planners, builders, investors, building experts and craftsmen all around the globe have come to rely on the innovative and durable WOLFEN products – no matter whether used for the refurbishment of old or the construction of new buildings. Tailored to the needs of craftsmen, WOLFEN products have become the international benchmark for long-life, economical and easy to install waterproofing systems that are the result of advanced manufacturing technology.

WOLFEN Bautechnik attaches great importance to high quality standards and ecologically sound solutions. This is why WOLFEN membranes can be recycled. The thermoplastic roofing and waterproofing membranes cover a wide range of possible applications: they protect flat roofs, wa-

terproof buildings in compliance with DIN 18195 or take care of special jobs, e.g. waterproofing according to the German Water Resources Act. An extensive range of services is additional proof of the know-how and expertise that customers have come to expect from WOLFEN Bautechnik.

We at WOLFEN are committed to sustainability.

In many European countries, our customers can benefit from the ROOF-COLLECT System (e.g. in Germany, Austria, Switzerland, the Netherlands and France). Neatly separated old thermoplastic roofing and waterproofing membranes can be returned for recycling if the refurbishment project is undertaken with WOLFEN products. Collection of the old membranes is carried out by Interseroh.



Central Station, Berlin



Galeria Department Store, Stuttgart



EAM, Kassel



Reichstag, Berlin



Contents

WOLFEN Application Range	4	WOLFEN System Components	
WOLFEN Quality Features	6	WOLFEN System Components	22
WOLFEN Refurbishment	8	WOLFEN Stainless Steel Components	24
WOLFEN Roofing and Waterproofing Membranes		WOLFEN Composite Metal Sheets	26
WOLFEN IB	10	WITEC Membrane System	28
WOLFEN M	14	WOLFEN Flex	30
WOLFEN GWSK and GWSK DA	16		
CE Product Data	20		
Chemical Resistance of WOLFEN Membranes	21		

Possible Applications of the WOLFEN System

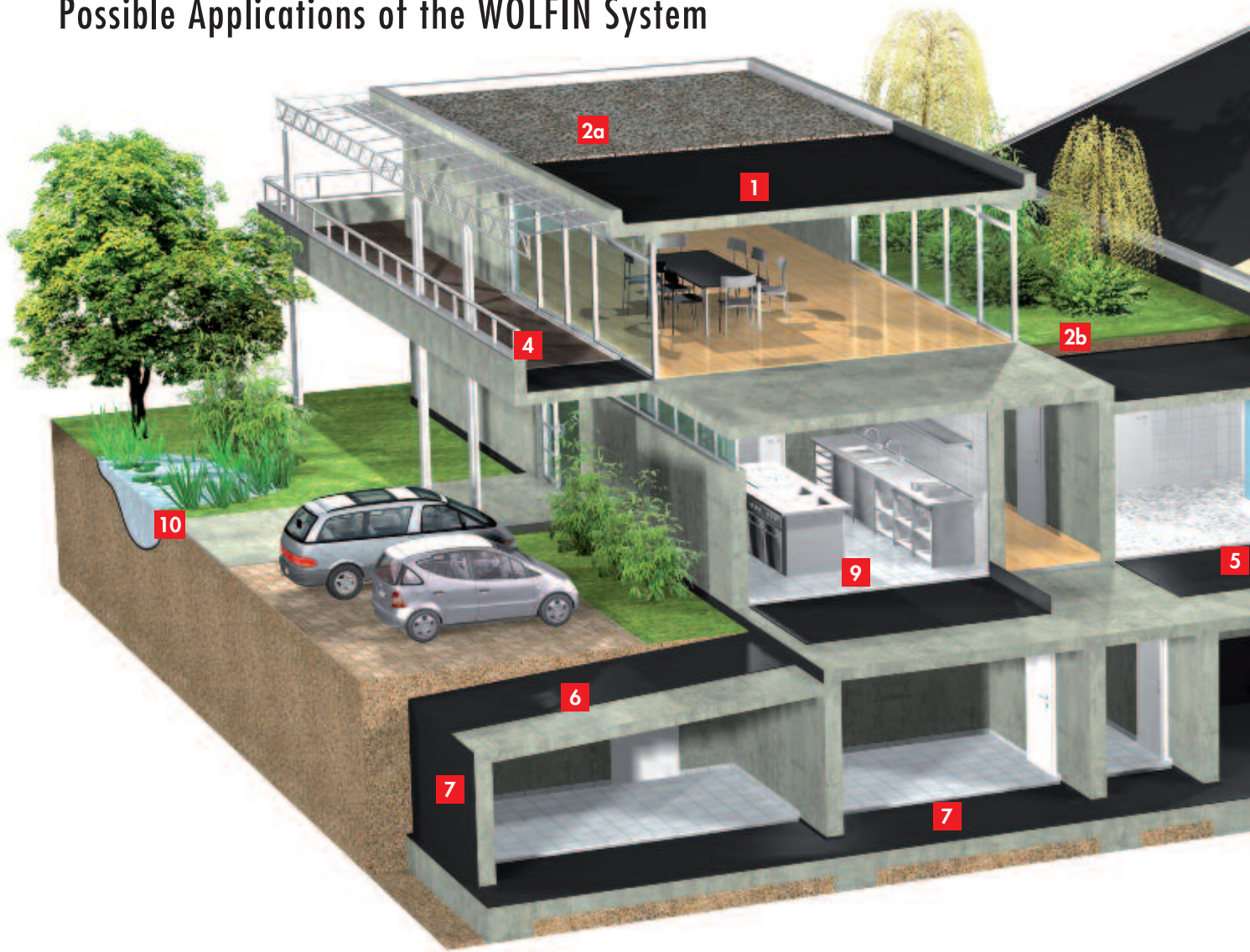

The WOLFEN range of services:

- Project-related refurbishment proposals
- Detailed technical drawings, CAD
- Condensation risk analysis
- Wind load calculations
- Practical training courses
- Building project support
- Other services

- | | |
|-----------|--|
| 1 | Flat roof waterproofing – uncovered, bonded installation |
| 2a | Flat roof waterproofing – loose or bonded installation under gravel |
| 2b | Flat roof waterproofing – loose or bonded installation on green roofs |
| 3 | Loose lay, mechanically secured |
| 4 | Waterproofing of balconies and patios according to the Flat Roof Guidelines and DIN 18195, part 5 |
| 5 | Waterproofing of wet rooms according to DIN 18195, part 5 |
| 6 | Waterproofing of cellar ceilings and parking decks according to DIN 18195, part 5 (PYE) |
| 7 | Waterproofing of base plates and cellar walls according to DIN 18195, part 4 |
| 8 | Waterproofing in compliance with the German Water Resources Act (WHG § 19), e.g. waterproofing of tank rooms |
| 9 | Waterproofing of commercial kitchens |
| 10 | Waterproofing of garden ponds |

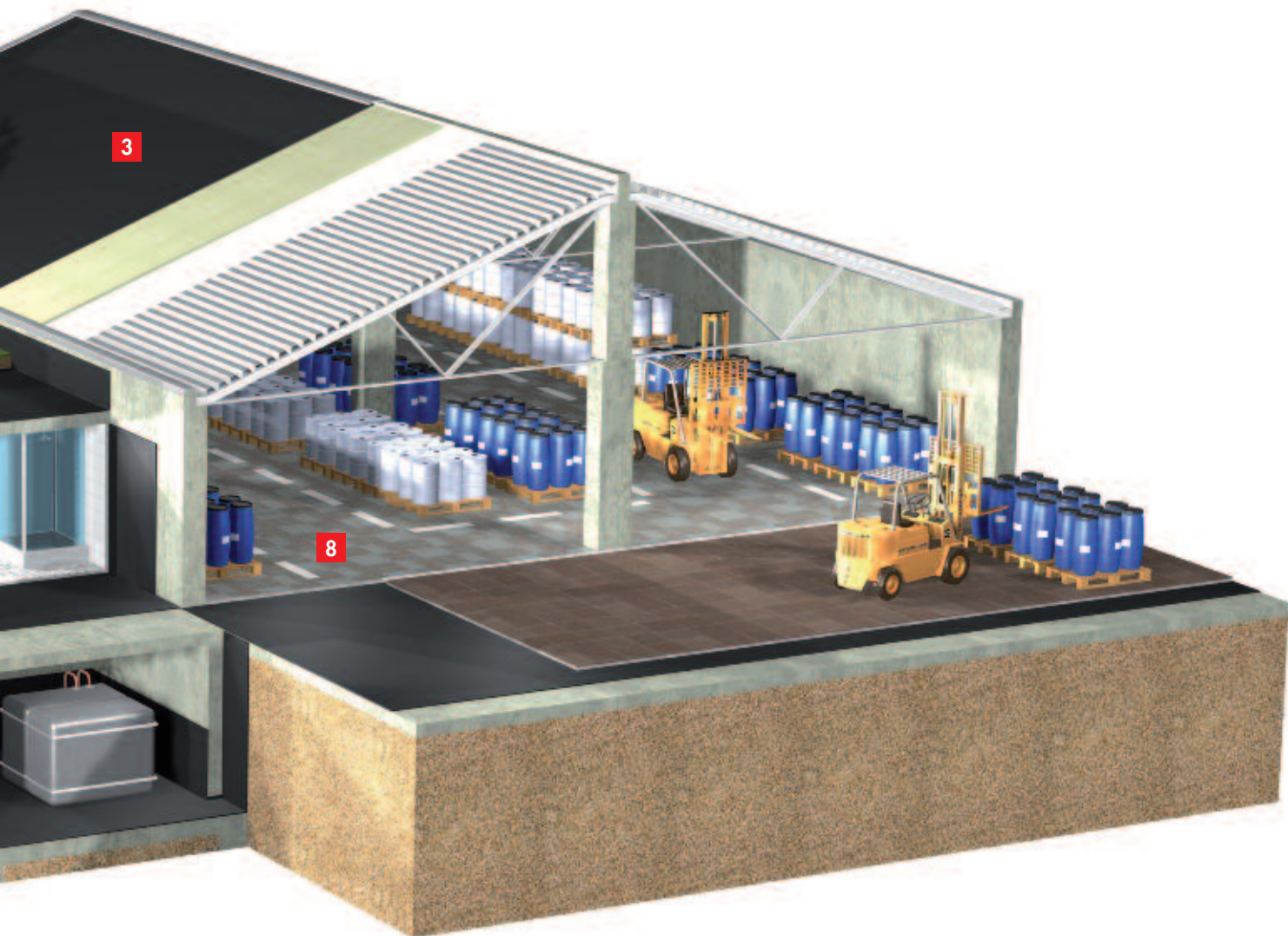

The right product for every application and every type of installation

	WOLFIN IB	WOLFIN M	WOLFIN GWSK	WOLFIN GWSK DA
			✓	✓
	✓	✓	✓	✓
	✓	✓	✓	✓
		✓		
	✓	✓	✓	
	✓	✓	✓	
	✓			
	✓	✓	✓	
	IB/W			
	✓	✓	✓	
	✓	✓		



WOLFIN stands for superior quality

Homogeneous – through and through

WOLFIN membranes are single-ply, entirely homogeneous, high polymer roofing and waterproofing membranes that meet the requirements of DIN EN 13956 and DIN EN 13967. WOLFIN membranes are free of monomeric plasticizers. The content of high polymer materials is above 94 %.

WOLFIN membranes neither contain fillers nor substances that may be washed out after prolonged exposure to water. Thanks to their unique formulation, WOLFIN membranes can be manufactured without additional flameproofing agents. Recent tests carried out on a 25-year-old WOLFIN membrane, laid under ballast, showed no change in the

membrane's physical values from those of the original product. The membrane has therefore proved to be well resistant to ageing. The results are available upon request.

More than 50 years of experience – in all climatic zones

Whether for refurbishment or for new construction: WOLFIN membranes have been successfully installed for more than 50 years on all continents of the globe, covering millions of square metres of flat roofs and building surfaces. No matter whether loosely laid, mechanically secured, bonded, laid under roof vegetation or other ballast materials.

WOLFIN is ...

Resistant to plant roots

In a long-term trial, WOLFIN membranes were tested for their resistance to plant root penetration following the rigorous test criteria of the FLL method. They successfully passed the test. WOLFIN can look back on more than 50 years of practical experience in the waterproofing of buildings and protection against plant roots.

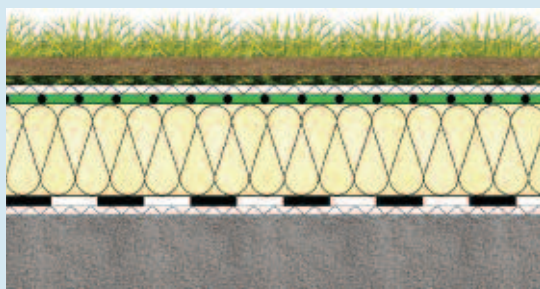

WOLFIN membranes reliably protect the roof covering from damage caused by spontaneous plant growth.

Uniform properties – all year round

For several decades now, WOLFIN membranes have been manufactured with the same formulation and finish. Thanks to a sophisticated formulation and consistently high manufacturing quality which is also monitored by external institutes, there is no need for separate summer and winter formulations. WOLFIN membranes are flexible and easy to install – all year round.

Workability throughout its life

WOLFIN membranes are weldable even after prolonged weather exposure. Caused by UV radiation, the surfaces of thermoplastic and rubber membranes tend to oxidize. This oxidized layer must be removed before homogeneous welding is possible. WOLFIN membranes feature lifelong weldability, whether by solvent or hot air. Any existing oxide layer can be removed with minimal effort.

Protection of assets and nature: Maximum resistance to chemicals

WOLFIN membranes have an extremely high resistance to chemicals. They are, for example, resistant to kerosene, oils and fats, sulphuric acid and lactic acid (85 % concentration) which is essential when waterproofing kitchens. WOLFIN IB has been approved for waterproofing collection and retention basins that are used for storing water-polluting liquids in line with the building and test principles of the DIBt Berlin (German Institute for Construction Technology, Z-59.21-8). (A list of chemicals approved in compliance with the German Water Resources Act WHG is available upon request.)

Unrivalled bitumen resistance

Compared to other thermoplastic roofing and waterproofing membranes, the bitumen resistance of WOLFIN membranes is truly unique. Independent tests prove conclusively that the resistance of WOLFIN by far exceeds the requirements stipulated by the relevant standards. WOLFIN membranes show practically no changes due to swelling or weight loss. The advantages are obvious:

- No separation layers are required between WOLFIN and bituminous membranes. Whether new or old bitumen, WOLFIN can be in direct contact with both:



WOLFIN membrane and bitumen in direct contact.

- Diffusing flux oils can migrate through the WOLFIN membrane without damaging it.



Flux oils escape but do not damage WOLFIN membranes.

- Bitumen on craftsmen's shoes and clothing does not harm WOLFIN membranes.



- Emissions from power stations, steelworks, cars and factory chimneys do not harm WOLFIN membranes.



- Asphalt and bitumen dust that may deposit when recycling roads do not harm WOLFIN membrane.

Resistant to microbes

Microbes and bacteria form in dirt deposits, gravel and puddles. But WOLFIN is resistant to them. WOLFIN membranes therefore need no special anti-microbial finish. Whether uncovered, ballasted or laid on a green roof: there is only one WOLFIN formulation.

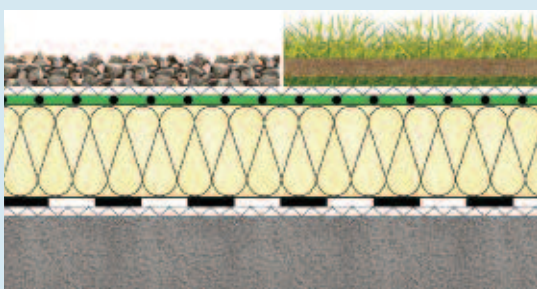

Resistant to red algae

Red algae colonies form in puddles on the roof. But WOLFIN is resistant to red algae. Also humic acid and loamy soil are no problem for quality membranes made by WOLFIN.

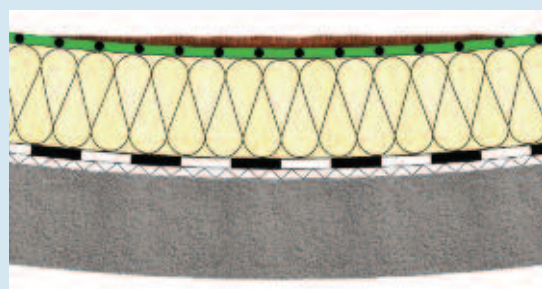



University hospital, Münster

The Roof Refurbishment Specialist

WOLFIN dries out existing failed roofs

Of all the thermoplastic roofing and waterproofing membranes available in the market, WOLFIN offers the highest water vapour diffusion permeability. It is the only membrane with a μ -value of just 13,000 which corresponds to an s_d -value of 19 m (membrane thickness of 1.5 mm).

Thanks to the unique formulation and the black colour of WOLFIN membranes, the roof layers rapidly heat up under the influence of solar radiation (max. 70 °C). This causes a

high vapour pressure that gradually dries out the trapped moisture. The effectiveness of this physical process has been confirmed by recent scientific test results provided by the Fraunhofer Institute, Holzkirchen/Germany.

The test results clearly show: The moisture trapped in the roof layers completely dries out after just a couple of years when renovating the roof with WOLFIN.

The dry-out process of a multi-layer roof

Phase 1

Preserve the old roof layers, perforate the existing waterproofing membrane (5 holes/m², diameter approx. 25 mm), if necessary install additional insulation according to EnEV and waterproof the roof with WOLFIN (colour: black).

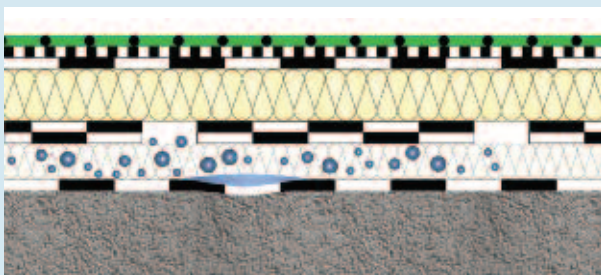

Status: Moisture has penetrated the old roof insulation and there are wet spots in the roof valleys.

Phase 2

The black colour of the WOLFIN membrane causes the roof layers to gradually heat up. The moisture begins to spread through the single layers.

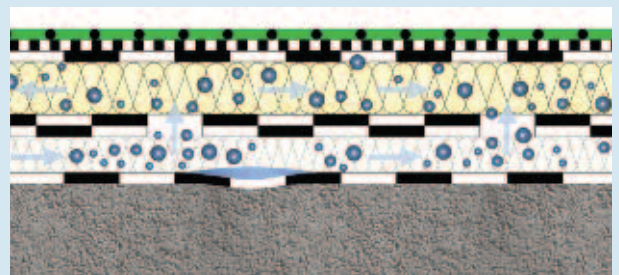

Status: Spread of moisture in the roof layers and the start of the drying process.

No need for hasty demolition!

Moisture trapped in the insulation – this is not unusual in the dew period (winter) and is harmless to a certain extent. DIN 4108, part 3, looks at the topic of “Condensate formation inside structural components”:

The formation of condensation within the roof construction is harmless if the thermal insulation and structural stability of the components are not endangered by increasing the humidity content of the construction materials and insulation materials. This is the case as provided for by DIN 4108-03 if the following conditions are fulfilled:

- a) It must be possible during the evaporation period to release to the environment the water that occurs within the roof construction during the dew period.
- b) The building materials that come into contact with the condensate must not be damaged (e.g. by corrosion or fungal decay).
- c) A total area-related condensate mass of 1.0 kg/m² must not be exceeded for the water-absorbable layers of roof and wall constructions.

If, however, larger amounts of water have accumulated in the roof layers because the old waterproofing is leaking, then we would recommend the refurbishment of the roof with WOLFEN to restore a tight and well-functioning layered structure.

The well-proven alternative to complete demolition

Refurbishment with WOLFEN roofing and waterproofing membranes has been a tried and trusted solution for more than 50 years. The old set of layers is retained or, if necessary, supplemented by an additional insulation layer. After that, the complete structure is protected with a new WOLFEN membrane. Usually, the combined use of these products causes the roof to dry out after just a few years. Decisive factors of success: the special WOLFEN formulation, the high water vapour diffusibility (s_d -value of just 19 m) and the black colour of the membrane.

When exposed to sunshine, the roof layers underneath the black membrane heat up and the moisture evaporates more quickly. Compared to light-coloured membranes, the drying effect of black membranes is three times as high over the same period.

The validity of this method has also been confirmed by building physicists. Several years ago, the building authority of Hamburg published a brochure which explicitly recommended the preservation of the moist thermal insulation when refurbishing the roof.

Save costs, nature and resources

When undertaking a roof refurbishment project, the use of WOLFEN products will considerably lower your costs since you can save the expense of demolishing the roof and the expensive disposal of waste. By avoiding construction waste, you can also actively help to preserve the environment.

So, why pull down the complete structure?

Put your trust into additional insulation reliably protected by WOLFEN roofing/waterproofing membranes and its complimentary system components.

Refurbishment: Comparison of working steps

	Classical refurbishment	WOLFEN refurbishment
Demolition	■	
Disposal	■	
Bitumen primer (if necessary)	■	
New vapour barrier	■	
Completely new insulation	■	
Perforation and additional insulation		■
New waterproofing layer	■	■

Phase 3

The moisture spreads evenly through the insulation layers – both horizontally and vertically. The entire surface of the WOLFEN membrane is utilized for the dry-out effect, thus speeding up the process.

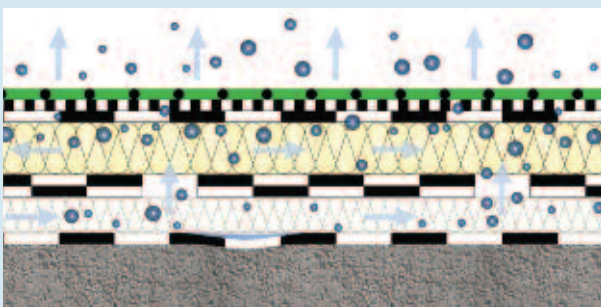

Status: The degree of moisture penetration is drastically reduced.

Phase 4

The roof dries out completely. In the test carried out by the Fraunhofer Institute the drying process took approximately 2 years.

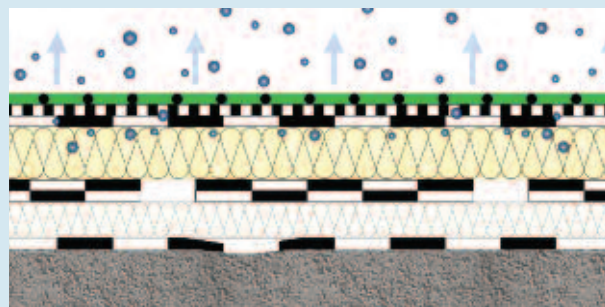

Status: The moisture content tends towards zero. The long service life of the WOLFEN membrane ensures durable protection of the roof.

Haus zur Wildnis, Bavaria



WOLFIN IB

Security and longevity that meet the highest demands

For more than 50 years, **WOLFIN IB** has been used to ensure reliable, high-quality waterproofing. WOLFIN IB is a bitumen-resistant membrane that has been plasticized with polyester. It features high permeability to diffusion and is therefore ideally suited for the refurbishment of old and the construction of new roofs. On flat roofs, WOLFIN IB is suitable for loose laying under ballast. When waterproofing buildings in compliance with DIN 18195, the WOLFIN PYE composite system offers a particularly high level of weather security. WOLFIN IB has been approved by the national construction supervising authorities for waterproofing work according to § 19 of the German Water Resources Act.

Thanks to its high resistance to chemicals, WOLFIN IB is also an ideal product for special waterproofing jobs.

WOLFIN IB roofing and waterproofing membranes are bitumen-resistant membranes that have been plasticized with polyester and are based on polyvinyl chloride (PVC-P-BV). They are produced by extrusion, consist of a single ply (not double-layered), are homogeneous throughout and available in a variety of thicknesses. WOLFIN IB is permeable to water vapour diffusion (13,000 μ), resistant to bitumen, flux oil, fatty acid and kerosene, and can be welded by hot air or solvent at any time during its service life.

How to install WOLFIN IB

New building

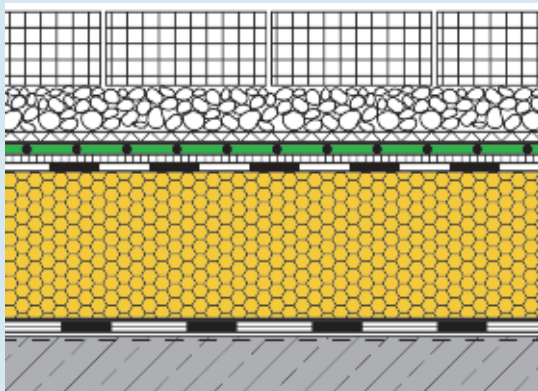

WOLFIN PYE composite system

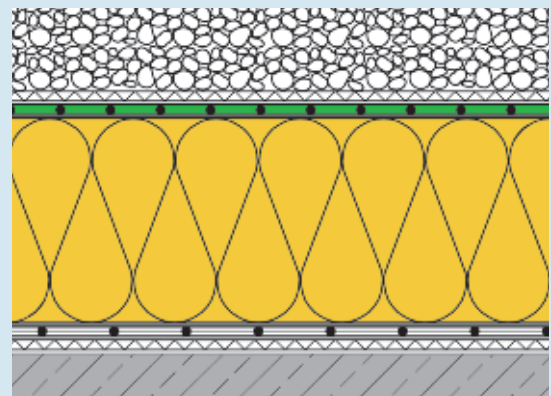

Loose lay under ballast

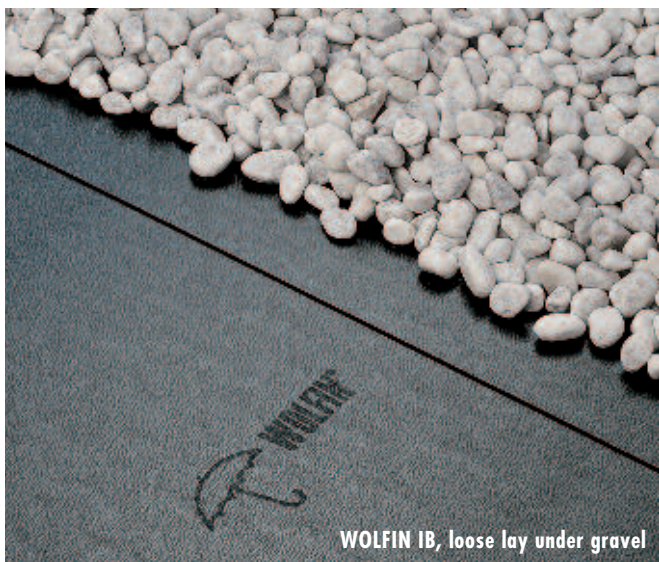

WOLFIN IB, loose lay under gravel



WOLFIN IB under a green roof

Classifications / approvals according to:

- DIN EN 13501-1 (class E)
- DIN EN 13956 CE Waterproofing of Roofs
- DIN EN 13967 CE Waterproofing of Buildings
- DIN EN 18531 (Waterproofing of Roofs)
- DIN 18195 (Waterproofing of Buildings)
- DIN V 20000-201 and DIN V 20000-202



Single-ply, without reinforcement, without rear lamination

Refurbishment –
Preservation of the existing roof layers

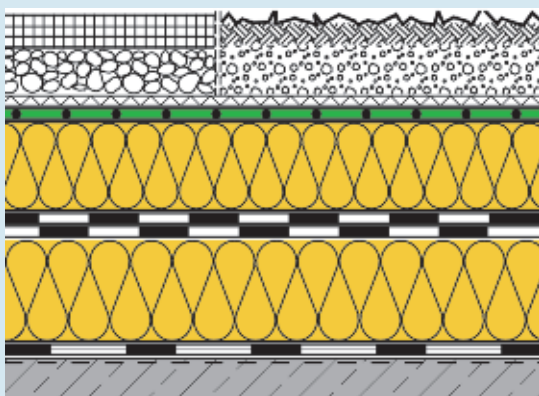

Loose lay under ballast

RANGE OF AVAILABLE WOLFIN IB MEMBRANES

WOLFIN IB membranes, black

Product name	Thickness mm	Width mm	Length m	Area m ²
WOLFIN IB	1.2*	1,620	20	32.40
WOLFIN IB	1.5	1,100	15	16.50
WOLFIN IB	1.5	1,620	15	24.30
WOLFIN IB	2.0	1,100	10	11.00
WOLFIN IB	2.0	1,620	10	16.20

WOLFIN IB strip, black

Product name	Thickness mm	Width mm	Length m	Area m ²
WOLFIN IB	1.5	150	15	2.25
WOLFIN IB	1.5	250	15	3.75
WOLFIN IB	1.5	350	15	5.25
WOLFIN IB	1.5	550	15	8.25

WOLFIN IB membranes, grey***

Product name	Thickness mm	Width mm	Length m	Area m ²
WOLFIN IB	1.5	1,100	15	16.50
WOLFIN IB	1.5	1,620	15	24.30
WOLFIN IB**	2.0	1,620	10	16.20

WOLFIN IB cuttings, grey***

Product name	Thickness mm	Width mm	Length m	Area m ²
WOLFIN IB	1.5	150	15	2.25

* Only use as protection against root penetration, for waterproofing roofs under gravel ballast and for waterproofing buildings acc. to DIN 18195, part 4, part 5 moderate water load.

** Please ask for delivery time.

*** Other colours available on request.

Waterproofing against ground water

Factories, factory components and technical devices for protecting factories that handle water-polluting substances like oil, petrol and fatty acids must comply with the necessary statutory regulations. These include, for instance, the German Water Resources Act (WHG), the Building Law and the Industrial Safety Act. The German Institute for Construction Technology (DIBt) grants National Technical Approvals for waterproofing products that are used for waterproofing so-called LAU facilities (plants for the storage, filling and handling of water-polluting substances). The requirements to be met by the materials as well as the test procedures for proving their suitability have been laid down in the approval principles issued by the DIBt.

WOLFIN IB is the product of choice when waterproofing in compliance with § 19 of the German Water Resources Act (WHG). WOLFIN IB has been approved for waterproofing catch basins and collection chambers in factories that are used for the storage of water-polluting liquids according to § 19 of the German Water Resources Act (approval number Z-59.21-8). This also includes the waterproofing of tank rooms. However, when waterproofing in compliance with the German Water Resources Act, it is always necessary to obtain the expert advice of our Application Technology Department. The result of this consultation must be confirmed by WOLFIN Bautechnik.

EXPOSURE CLASSES		
Load class	Description	Exposure time
Low	Short-term exposure	≤ 8 hours
Medium	Temporary exposure	≥ 8 hours and ≤ 72 hours
High	Long-term exposure	≥ 72 hours up to 3 months

Catch basin inside buildings with a protective covering

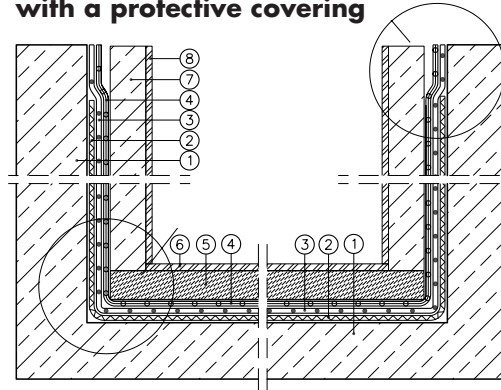

Floor area: ceramic tile covering
wall area: ceramic slab covering on a concrete curtain wall

1. Concrete of the catch basin
2. Protective fleece 400 g/m² (if necessary)
3. WOLFIN IB ≥ 1.5 mm
4. Double-layered polyethylene sheeting each layer 0.2 mm thick
5. Cement screed 50 mm WOLFIN IB ≥ 1.5 mm
6. Ceramic slab covering
7. Concrete curtain wall ≤ 100 mm
8. Ceramic slab covering

Outdoor catch basin with a protective gravel packing, embedded into the dam crest

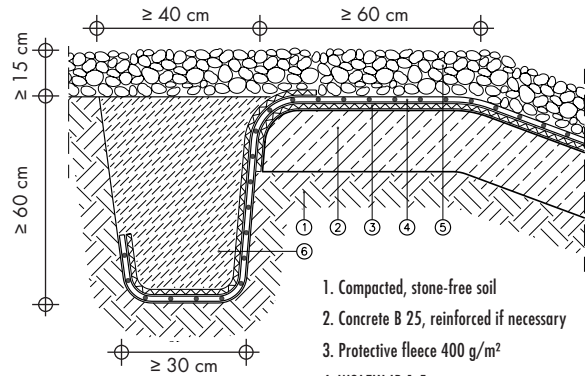

1. Compacted, stone-free soil
2. Concrete B 25, reinforced if necessary
3. Protective fleece 400 g/m²
4. WOLFIN IB 1.5 mm
5. Protective gravel packing, min. thickness 15 cm, washed shingle 8/32 mm with a uniform grading
6. Perimeter anchor backfilled with lean concrete on a protective fleece 400 g/m²

When placing the waterproofing membranes, they should be rounded with a radius of approx. 8 cm!

For further planning details for waterproofing work in compliance with WHG § 19 please contact our Application Technology Department.

Applications in compliance with WHG § 19

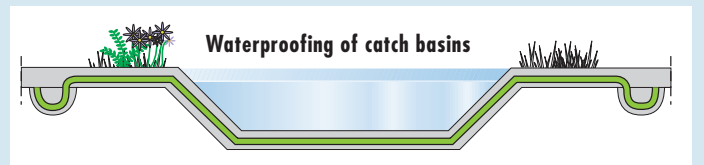
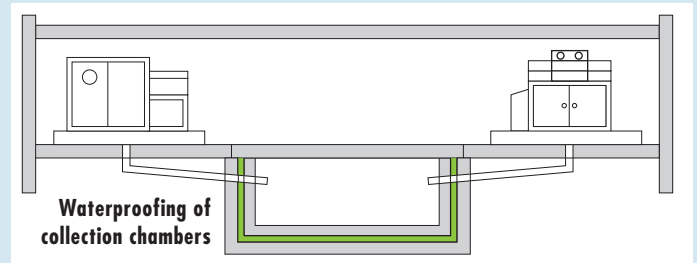
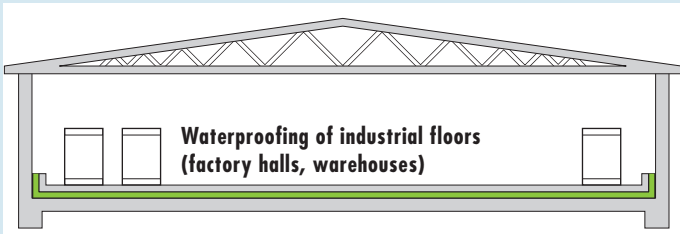

WOLFIN PYE composite system for structural waterproofing acc. to DIN 18195

Damage to the waterproofing layers outside of buildings is not only annoying, but can also prove costly. In most cases, the cost of refurbishment exceeds the cost of investment since high-quality wearing surfaces need to be removed. In the case of multi-ply, loose-lay roof constructions, the location of the damage is quite difficult since the penetrating water can spread over large areas underneath the waterproofing layer. When trying to remedy the damage, this not only causes trouble with the building owner, but also often results in downtimes or loss of use.

Highest security standard

For this reason, the WOLFIN PYE composite system was developed jointly with our technicians. It offers the highest possible degree of security when carrying out structural waterproofing in compliance with DIN 18195. The system protects against capillary seepage of water as proven by the test certificate. In addition, the WOLFIN roofing and waterproofing membrane is resistant to root penetration and resistant to the attack of substances like engine oil from parked vehicles.

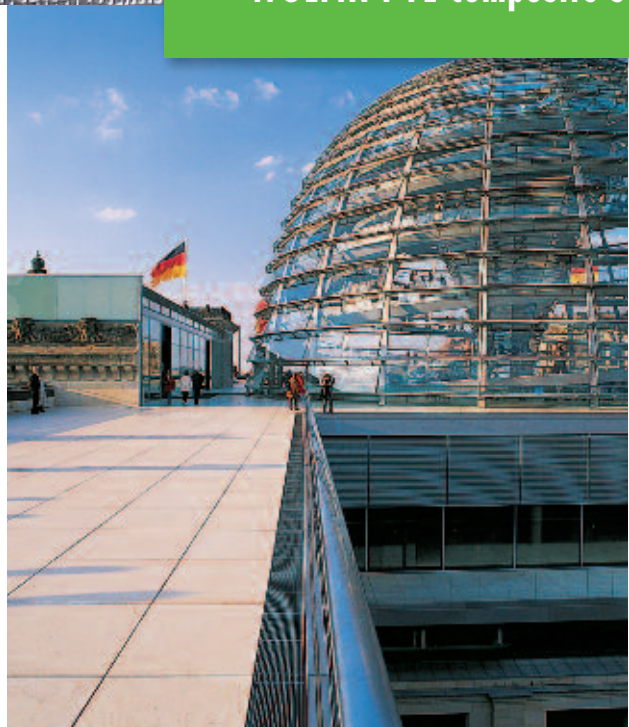

Fail-safe waterproofing with the WOLFIN PYE system: the roof of the Reichstag building in Berlin.



Waterproofing without thermal insulation

When waterproofing surfaces without a previously installed layer of thermal insulation, the bare concrete floor is first pretreated with a cold bitumen primer. After that, a PYE polymer bitumen membrane is torched over the full surface area. The top layer consists of a bitumen-resistant WOLFIN roofing and waterproofing membrane: it is rolled into the heat-liquefied bitumen surface over the full area to be covered. Both waterproofing layers are seep-proof and protect against capillary seepage.

Waterproofing with thermal insulation

In this case, the foam glass panels are first immersed in hot bitumen. After that, the panels are covered with a first waterproofing membrane made of PYE polymer bitumen. This layer is installed using the pour & roll method. On top of this, a WOLFIN roofing and waterproofing membrane is applied using the torch-on method as shown on the left.

Tried and tested for the following applications:

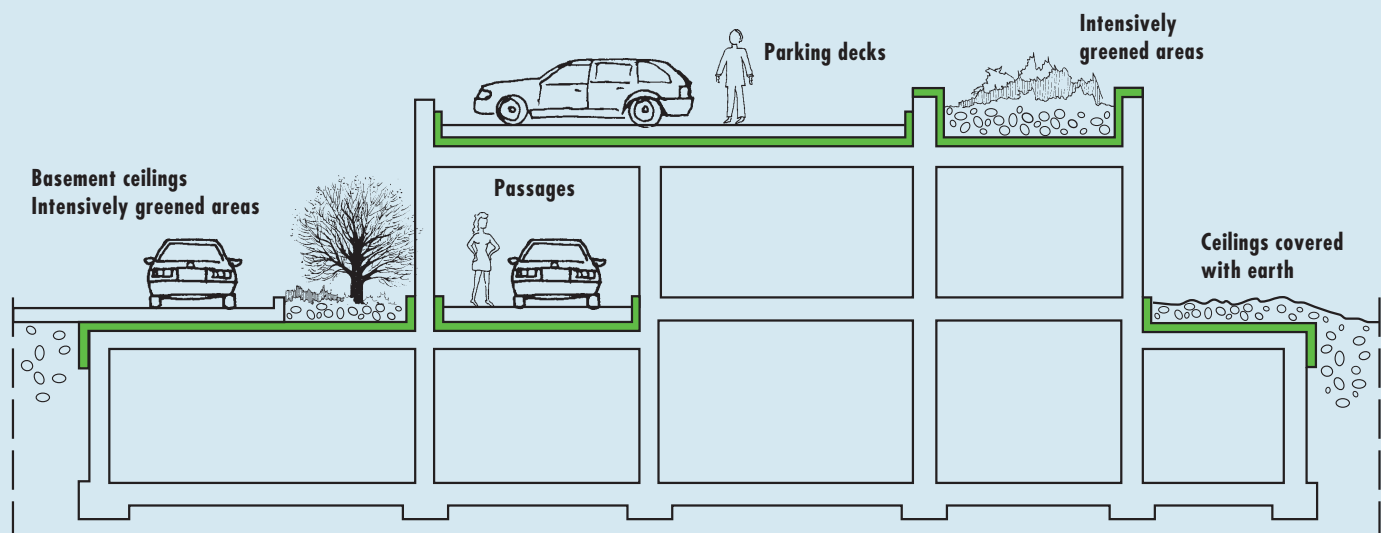

A detailed Installation Guide is available on request from the Wolfin's Technical Department.



Logistikhalle, Genthin

WOLFIN M

High-quality, mechanically fastened waterproofing of flat roofs

WOLFIN M is a bitumen-resistant, thermoplastic roofing membrane with an integral glass fibre reinforcement. It features a high permeability to water vapour diffusion (13,000 μ) and is therefore ideally suited for the renovation of old and the construction of new buildings. WOLFIN M membranes have been plasticized with polyester and are based on polyvinyl chloride (PVC-P-BV). They are produced by extrusion and are therefore completely homogeneous – there is no difference in thickness between the top, middle and bottom layers. Moreover, they are available in a variety of thicknesses and can be either mechanically secured or laid loosely under ballast. WOLFIN M is permeable to flux oil, fatty acid and kerosene.

Classifications / approvals according to:

DIN EN 13501-1 (class E) as well as DIN 4102-7
(Class A fire rated roof covering) and EN 13501-5 B_{ROOF} (t1)
according to DIN ENV 1187
DIN EN 13956 CE Waterproofing of Roofs
DIN EN 13967 CE Waterproofing of Buildings
Test certificate AbP no. P-1.3-SKZ-351
DIN EN 18531 (Waterproofing of Roofs)
DIN 18195 (Waterproofing of Buildings)
DIN V 20000-201 and DIN V 20000-202
ETA-09/0204 after ETAG 006 for mechanical fixed roofing systems

How to install WOLFIN M

New building

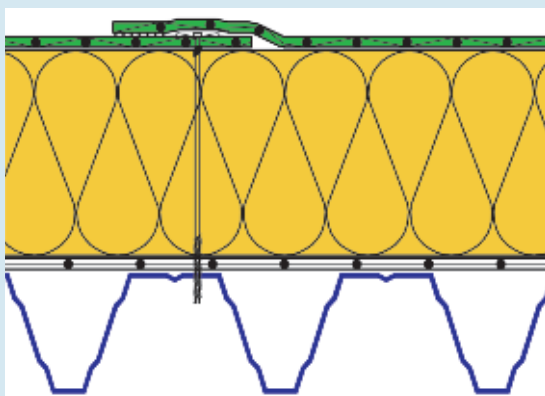

Mechanically secured roof layers

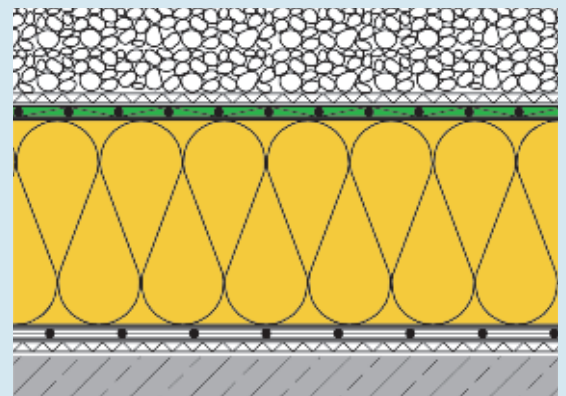

Loose lay under ballast

WOLFIN M – also available in grey



RANGE OF AVAILABLE WOLFIN M MEMBRANES

WOLFIN M membranes, black

Product name	Thickness mm	Width mm	Length m	Area m ²
WOLFIN M	1.5	1.100	15	16.50
WOLFIN M	1.5	1.620	15	24.30
WOLFIN M	2.0	1.100	10	11.00
WOLFIN M	2.0	1.620	10	16.20

WOLFIN M membranes, grey

Product name	Thickness mm	Width mm	Length m	Area m ²
WOLFIN M	1.5	1,100	15	16.50
WOLFIN M	1.5	1,620	15	24.30
WOLFIN M	2.0*	1,100	10	11.00
WOLFIN M	2.0*	1,620	10	16.20

* Please ask for delivery time.



Fast and efficient – with a professional tool for automatic fastening

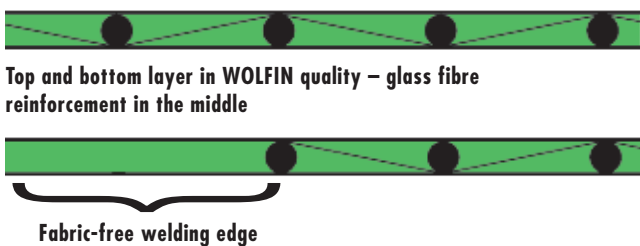

Refurbishment and waterproofing of green roofs with WOLFIN M

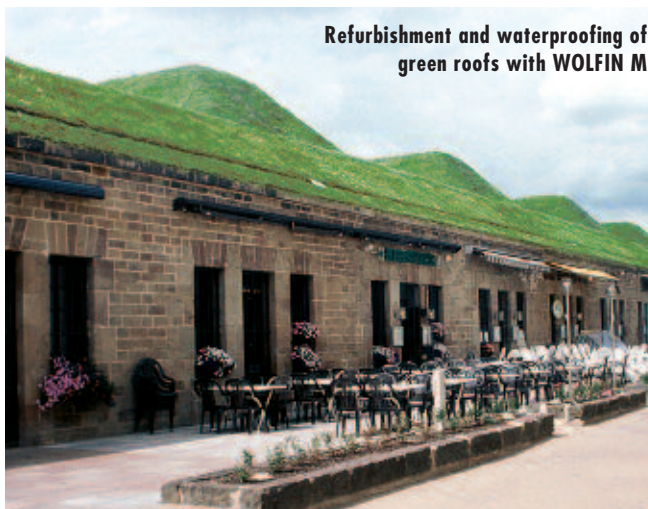

Refurbishment – Preservation of the existing roof layers

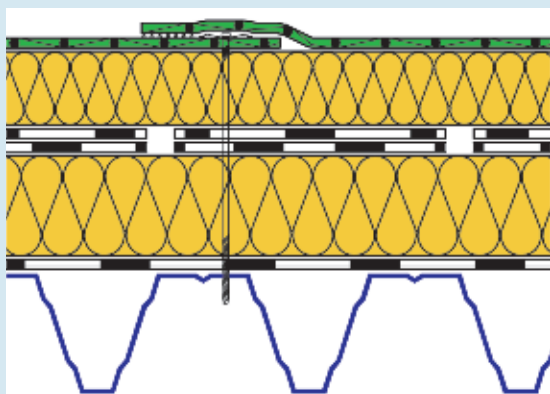

Mechanically secured layered structure, also repair of damp layers on old roofs

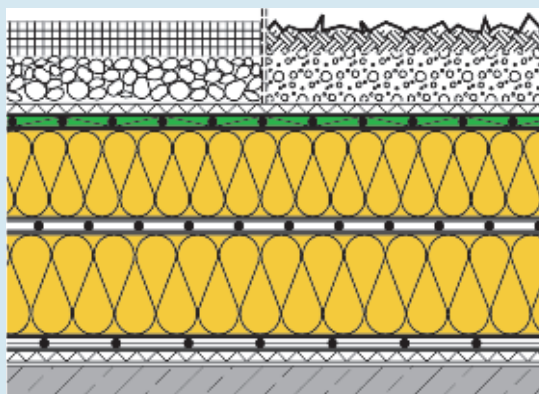

Loose lay under ballast



State Council Building, Berlin

WOLFIN GWSK

Fast and fire-safe waterproofing

protect

In principle, WOLFIN GWSK roofing and waterproofing membranes consist of the same materials as WOLFIN IB membranes. In addition, however, they have been reinforced with an integrated fleece and come factory-fitted with a self-adhesive layer. Thanks to the self-adhesive layer, the membranes can be securely positioned without the need for mechanical fasteners or ballast. As a result, flat roofs can be waterproofed more quickly and more economically. WOLFIN GWSK ensures a homogeneous surface, in the field areas and at the laps, thanks to a welding edge that is tack-free on one side. The membrane is bonded to the roof surface. It can be used both for the construction of new and the renovation of old roofs (also special roof types).

Equipped with a protective fleece

The new WOLFIN GWSK once more provides impressive proof of the innovative power of WOLFIN Bautechnik. **The new WOLFIN GWSK with a protective fleece successfully passed the fire test in compliance with DIN 4102, part 7.** This test result applies to all roof slopes and to direct bonding on polystyrene.

Due to its special formulation without additional fireproofing agents, WOLFIN GWSK has a very low fire load and thus offers a very high fire protection effect. In the event of

How to install WOLFIN GWSK

New buildings

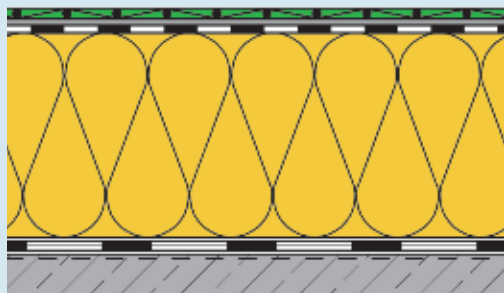

Bonded layer build-up

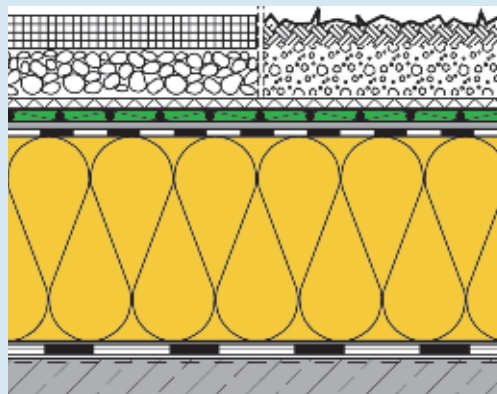

Bonded layer build-up under ballast

Refurbishment – Preservation of the existing roof

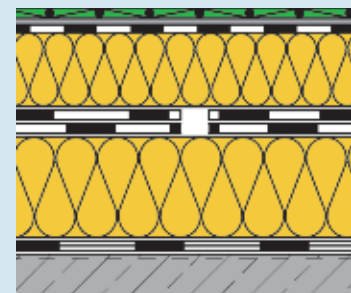

Bonded layer build-up



fire, the special formulation – combined with the integrated protective fleece – prevents the fire from burning through the membrane down to the thermal insulation. WOLFIN GWSK with protective fleece offers a combination of several advantages. If necessary, the membrane can be directly bonded on an insulation layer made of high-quality polystyrene (at least EPS DAA dh/PS-30). Installation of the membrane is as easy and user-friendly as craftsmen have come to expect from WOLFIN.

Classifications / approvals according to:

- DIN EN 13501-1 (class E) as well as DIN 4102-7
- (Class A fire rated roof covering) and EN 13501-5 B_{ROOF} (t1) according to DIN ENV 1187
- DIN EN 13956 CE Waterproofing of Roofs
- DIN EN 13967 CE Waterproofing of Buildings
- DIN EN 18531 (Waterproofing of Roofs)
- DIN 18195 (Waterproofing of Buildings)
- DIN V 20000-201 and DIN V 20000-202

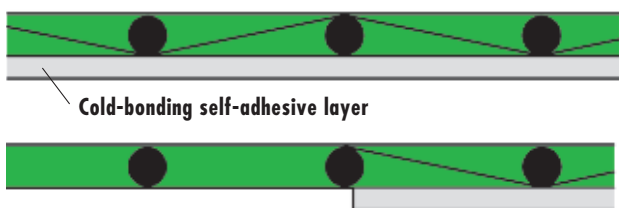

layers

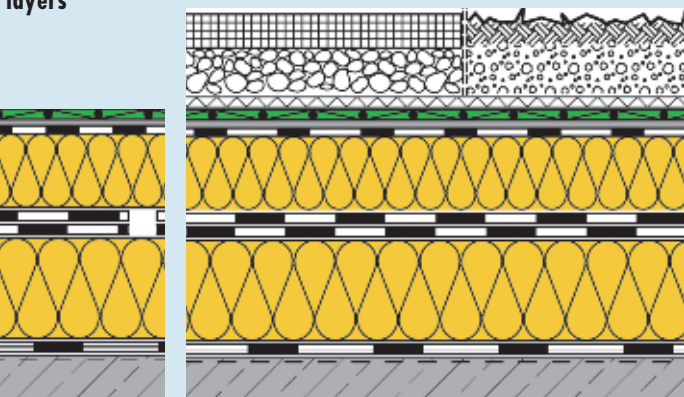

Bonded layer build-up under ballast

RANGE OF AVAILABLE WOLFIN GWSK MEMBRANES

WOLFIN GWSK membranes, black

Product name	Thickness* mm	Width mm	Length m	Area m ²
WOLFIN GWSK	2.3	1,100	15	16.50
WOLFIN GWSK	2.3	1,620	10	16.20
WOLFIN GWSK*	2.8	1,100	10	11.00

WOLFIN GWSK membranes, grey**

Product name	Thickness* mm	Width mm	Length m	Area m ²
WOLFIN GWSK	2.3	1,100	15	16.50
WOLFIN GWSK	2.3	1,620	10	16.20
WOLFIN GWSK**	2.8	1,100	10	11.00

WOLFIN GWSK DA membranes, black

Product name	Thickness* mm	Width mm	Length m	Area m ²
WOLFIN GWSK DA	2.3	1,100	15	16.50
WOLFIN GWSK DA	2.3	1,620	10	16.20
WOLFIN GWSK DA	2.8**	1,100	10	11.00

WOLFIN GWSK 2R connecting membrane with two welding edges, black

Product name	Thickness* mm	Width mm	Length m	Area m ²
WOLFIN GWSK 2R	2.3	1,100	15	16.95

WOLFIN IB strips for butt welds

Product name	Thickness mm	Width mm	Length m	Area m ²
WOLFIN IB, black or grey	1.5	150	15	2.25
WOLFIN IB, black	2.0	150	10	1.50

WOLFIN primer

Product name	Content
WOLFIN primer for GWSK black	25 l
WOLFIN special primer for GWSK grey	25 l

*All thickness values include the self-adhesive layer.
**Please ask for delivery time.

In contrast to WOLFIN GWSK black membranes, the grey membranes are equipped with a special transparent adhesive coating.

Cost-effective refurbishment

WOLFIN GWSKA DA roof- and waterproofing membranes help to optimize the refurbishment of bonded GWSKA roof layers. The GWSKA membranes are typically equipped with a self-adhesive layer which also has special drains for optimal vapour pressure equalization. The lateral spreading of the moisture and the low diffusion resistance help to speed up the drying-out of the roof considerably.

Due to the black colour of the WOLFIN membranes a high vapour pressure develops quickly when they are exposed to the sun rays, causing the roof layers to dry out efficiently.

Dismantling or refurbishment?

In case of refurbishment you have to keep calm and do what is best in terms of economy and ecology. Very often the existing roof layer can be preserved. The Fraunhofer-Institute for building-physics in Holzkirchen has come to this conclusion after a practical test made over several years with WOLFIN roofing- and waterproofing membranes.



Degussa, Rheinfelden



University Hospital, Münster

It is usual nowadays for refurbishment projects to involve additional insulation in connection with new waterproofing. It does not matter if the existing roof construction is wet. By using WOLFIN roofing- and waterproofing membranes failed flat roofs can be dried out after only a few years.

It will be necessary to conduct a roof condition survey prior to the roof refurbishment in order to establish the existing roof build up and condition. All structural implications must also be considered. Only then is it possible to decide on the best refurbishment methods.

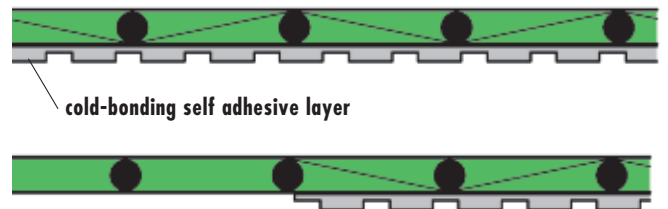

Optimized for refurbishment



GWSK DA: a combination of safe bonding and drains in order to optimize the vapour pressure equalization

Refurbishment – Preservation of the existing roof

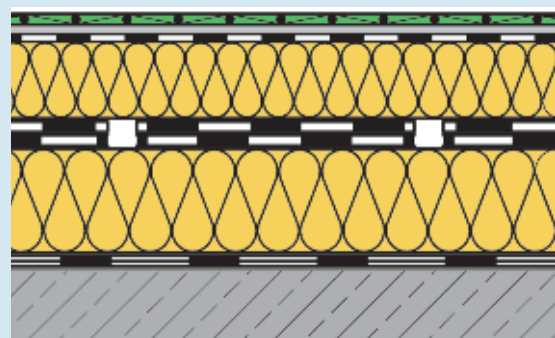

Bonded layer build-up, drainage of existing roof layers

Chemical resistance of WOLFIN membranes

ORGANIC CHEMICALS		
Aliphatic compounds		
Petroleum ether		+
Cyclohexane		+
Decalin		+
Methylene chloride		▲
Ethanol		+
Glycol		+
Acetone		●
Formic acid	up to 88%	+
Acetic acid	up to 20%	+
Oleic acid		+
Lactic acid	up to 85%	+
Acrylic acid	up to 99.5%	▲
Aromatic compounds		
Benzene		▲
Xylene		●
Tetralin		+
White spirit-benzene	50:50	▲
Kerosene (paraffin)		+
Other chemicals		
Petrol		▲
Engine oil		+
Gear oil		+
Lubricating oil		+
Fuel oil		+
Diesel oil		+
Jet fuel		+
Silicone oil		+
Bleaching liquor	up to 40%	+
Disinfectants such as		
Tego 51		+
Somplex S25HD	1:1	+
Somplex S25HD	1:10	+
Wood treated with the following oils		
Xylamon		+
Xyladecor		+
Bondex		+
Consoleum		●
Carbolineum		▲
Sugar solution	up to 50%	+
Fertilizing salts		
Potash lye	saturated	+
Nitrophoska solution	saturated	+

INORGANIC CHEMICALS		
Acids and bases		
Hydrochloric acid	up to 35%	+
Sulphuric acid	up to 50%	+
Nitric acid	up to 10%	▲
Ammonia	concentrated	+
Caustic soda solution	up to 25%	+
Mixed acid (sulphuric and nitric acid)	up to 10%	+
Lime milk solution	saturated	+
Aqueous solutions		
Water		+
Hydrogen peroxide	up to 3%	+
Hydrogen peroxide	concentrated	▲
Sodium sulphite	up to 10%	+
Sodium sulphide	up to 10%	+
Sodium chloride	saturated	+
Sodium thiosulphate	up to 10%	+
Potassium chromate	up to 10%	+
Potassium bromide	saturated	+
Copper sulphate	up to 10%	+
Ammonium nitrate	up to 10%	+
Magnesium chloride	up to 10%	+
Key to symbols:		
Resistant		+
Limited resistance (swelling, partly followed by embrittlement)		●
Not resistant		▲

TECHNICAL INFORMATION – CE PRODUCT DATA ACCORDING TO DIN EN 13956 AND DIN EN 13967

				WOLFIN IB		
Property	Test method	Unit	Result	Result		
				1.2 mm	1.5 mm	2.0 mm
Visible defects	DIN EN 1850-2	–	Passed	Passed	Passed	Passed
Length	DIN EN 1848-2	m	MDV	20	15	10
Width	DIN EN 1848-2	m	MDV	1.1 / 1.61	1.1 / 1.62	1.1 / 1.62
Straightness	DIN EN 1848-2	mm	MLV	≤ 50	≤ 50	≤ 50
Flatness	DIN EN 1848-2	mm	MLV	≤ 10	≤ 10	≤ 10
Mass per unit area	DIN EN 1849-2	kg/m ²	MDV	1.5	1.9	2.5
Effective thickness	DIN EN 1849-2	mm	MDV	1.2	1.5	2
Water tightness	DIN EN 1928 B	kPa	MLV	Passed	Passed	Passed
External fire exposure	DIN ENV 1187	–	–	NPD	NPD	NPD
Reaction to fire	DIN EN 13501-1	–	–	E	E	E
Joint peel resistance	DIN EN 12316-2	N/50 mm	MLV	≥ 150	≥ 150	≥ 150
Joint shear resistance	DIN EN 12317-2	N/50 mm	MLV	NPD	≥ 600	≥ 600
Tensile strength	DIN EN 12311-2	N/50 mm	MLV	≥ 15	≥ 16	≥ 16
Elongation	DIN EN 12311-2	%	MLV	≥ 300	≥ 300	≥ 300
Resistance to impact Method A	DIN EN 12691	mm	MLV	≥ 500	≥ 600	750
Method B	DIN EN 12691	mm	MLV	≥ 500	≥ 600	750
Resistance to static load	DIN EN 12730 B	kg	MLV	≥ 20	≥ 20	≥ 20
Durable water tightness after ageing	DIN EN 1296 acc. to DIN EN 1928	–	Passed	Passed	Passed	Passed
Durable water tightness against chemicals	DIN EN 1847 acc. to DIN EN 1928	–	Passed	Passed	Passed	Passed
Nail tear resistance	DIN EN 12310-1	N	MLV	≥ 200	≥ 350	≥ 350
Tear resistance	DIN EN 12310-2	N	MLV	≥ 100	≥ 100	≥ 100
Resistance to root penetration	DIN EN 13948		Passed	NPD	Passed	Passed
Dimensional stability after warm storage	DIN EN 1107-2	%	MLV	≤ 1.5	≤ 1.5	≤ 1.5
Foldability in cold temperatures	DIN EN 495-5	°C	MLV	≤ -20	≤ -20	≤ -20
UV exposure	DIN EN 1297	Visual check	Passed	Passed	Passed	Passed
Hail resistance	DIN EN 13583	m/s	MLV	NPD	≥ 25	≥ 25
Water vapour permeability	DIN EN 1931	–	MDV	10,000 ± 3,000	10,000 ± 3,000	10,000 ± 3,000
Bitumen compatibility	DIN EN 1548	–	Passed	Passed 90 d / 70 °C	Passed 90 d / 70 °C	Passed 90 d / 70 °C

Information for users:

* Classification according to EN 13501-5; classification of further test set-ups in compliance with DIN 4102-7 can be provided.

** These values refer to new WOLFIN membranes.

Explanation:

MDV = Manufacturer's declared value

MLV = Manufacturer's limiting value

NPD = No performance determined

Last update: 06/2012

We reserve the right to make technical modifications in order to improve the product performance.

WOLFIN M		WOLFIN GWSK		WOLFIN PV
Result		Result		Result
1.5 mm	2.0 mm	2.3 mm	2.8 mm	3.0 mm***
Passed	Passed	Passed	Passed	Passed
15	10	15 / 10	10 / 10	15
1.1 / 1.62	1.1 / 1.62	1.1 / 1.62	1.1 / 1.62	1,62
≤ 50	≤ 50	≤ 50	≤ 50	≤ 50
≤ 10	≤ 10	≤ 10	≤ 10	≤ 10
1.9	2.5	2.7	3.3	2,76
1.5	2	1.5	2	2,0
Passed	Passed	Passed	Passed	Passed
B _{ROOF} (T1)*	B _{ROOF} (T1)*	B _{ROOF} (T1)*	B _{ROOF} (T1)*	B _{ROOF} (T1)*
E	E	E	E	E
≥ 300	≥ 300	NPD	NPD	≥ 250
≥ 800	≥ 800	≥ 600	≥ 600	≥ 600
≥ 800	≥ 800	≥ 10	≥ 10	≥ 600
≥ 2	≥ 2	≥ 200	≥ 200	≥ 50
600	750	≥ 600	≥ 750	600
600	750	≥ 600	≥ 750	1,000
≥ 20	≥ 20	≥ 20	≥ 20	≥ 20
Passed	Passed	Passed	Passed	Passed
Passed	Passed	Passed	Passed	Passed
≥ 400	≥ 400	≥ 400	≥ 400	≥ 500
≥ 250	≥ 250	≥ 175	≥ 175	≥ 200
Passed	Passed	Passed	Passed	Passed
≤ 0.5	≤ 0.5	≤ 0.5	≤ 0.5	≤ 1.0
≤ -20	≤ -20	≤ -25	≤ -25	≤ -25
Passed	Passed	Passed	Passed	Passed
≥ 25	≥ 25	≥ 25	≥ 25	≥ 25
10,000 ± 3,000	10,000 ± 3,000	25,000 ± 5,000	25,000 ± 5,000	20,000 ± 5,000
Passed 90 d / 70 °C	Passed 90 d / 70 °C	Passed 90 d / 70 °C	Passed 90 d / 70 °C	Passed 90 d / 70 °C





WOLFIN System Components

If you want perfect results when waterproofing flat roofs or buildings, you need optimally matched system components. In addition to high-quality membranes, WOLFIN also offers the necessary tools, pre-shaped components made of the same material as the membrane for waterproofing corners and ducts and, of course, tools for welding and sealing the membrane seams. These complementary products form a consistent system and help you build in the additional security you need.

Naturally, you can always rely on your own installation skill and shape the structural details by hand. But why not make your work easier and faster by using the pre-fabricated inner and outer corners from the WOLFIN range? These not only facilitate work on site and help you save precious time and cost, but also ensure reliable and lasting results.

Another component of the WOLFIN membrane system is the lightning rod protection sleeve. This device is ideally suited for waterproofing all kinds of penetrations and has a small diameter.



Mounting of Gravel Catch Bar

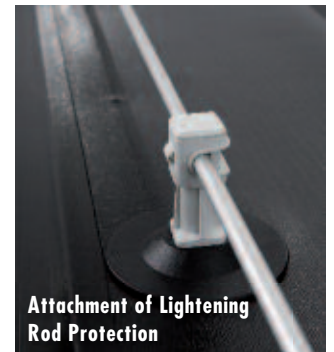

Attachment of Lightning Rod Protection

WOLFIN seam welding technique

Hot air welding



The seams of membrane strips on the roof surface can be welded by hot air (hand-held device or automatic welding machine). When waterproofing structural details, it is always necessary to use hot air welding, e.g. for inner and outer corners, T-butts or pipe collars.

Automatic welding

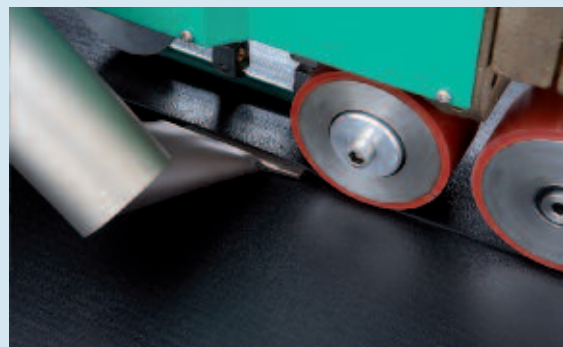

For long membrane seams it is recommendable to use an automatic welder. This ensures fast work progress and produces uniform results.





Lightning rod supports and fastening disks



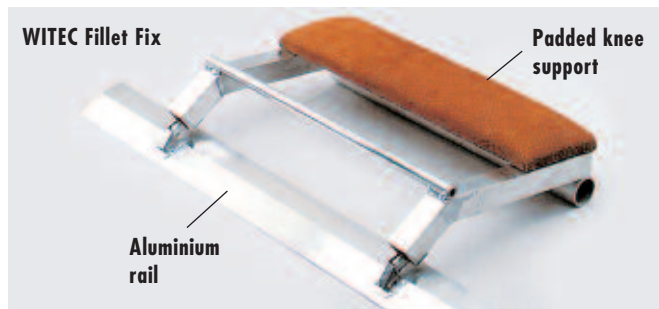

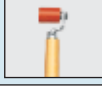

These components of the WOLFIN system are fixed directly on top of the membrane – either by solvent or hot air welding. If the fastening disk is used for securing gravel stop profiles in place, it is necessary to install a more rigid sub-construction consisting of metal sheet.

The "WITEC Fillet Fix"

The "WITEC Kehlfix" is an auxiliary device for welding roof valleys. It is equipped with a flexibly mounted aluminium rail and a padded knee support. When working in roof valleys, this device facilitates welding the surface membrane to the sheet metal profiles and allows the precise shaping and welding of roof valleys.



WITEC SPECIAL TOOLS	
WITEC spray bottle, 0.5 l	
WITEC rapid welding brush (for screwing onto the WITEC spray bottle)	
WITEC pressure roller, 40 mm, ball bearing mounted	
WITEC pressure roller, 80 mm, ball bearing mounted on both sides	
WITEC Fillet Fix Welding board for roof valleys	

WOLFIN SYSTEM COMPONENTS	
WOLFIN Solvent Welding Agents	
WITEC solvent welding agent	
WITEC cleaning agent	
WOLFIN Liquid for Seam Sealing	
WOLFIN liquid, black / grey	
WOLFIN Inner and Outer Corners	
WOLFIN inner corners, 90°, black / grey	
WOLFIN outer corners, 90°, black / grey	
WOLFIN Lightning Rod Protection	
WOLFIN lightning rod support with M6 stainless steel screw	
WOLFIN universal fastening disk with M6 stainless steel screw	
WOLFIN lightning rod sleeve, sleeve length: 250 mm Ø inner 20 mm Ø outer 25 mm	

Cold applied solvent welding agent



The solvent welding agent is injected from the spray bottle between the membrane strips overlapping by at least 4 cm. The agent is spread by light, rubbing movements of the brush. After that, the seam area is pressed down with a rubber roller.

Seam control



A test needle or scribe is used for checking the seams.



WOLFIN stainless steel vents and water outlets

Optimal connection for tight roofs

All WOLFIN system components have a stainless-steel composite sheet flange and a WOLFIN membrane flange to provide a homogeneous welding to the adjacent membrane areas. The grey membrane flange has a special formulation so that it can also be used with WOLFIN grey, TECTOFIN grey and COSMOFIN. This makes WOLFIN your best choice both for new buildings and for refurbishment projects. Existing systems are easy to upgrade at any time.

Advantages of the WOLFIN drainage system:

- Stainless steel, AISI 316 standard, for highest demands
- LGA tested
- Can be manufactured according to individual needs
- Cost-effective
- Material-homogeneous welding technology
- Superior drainage
- Approved systems with a long-term performance
- Durable, even at low temperatures
- Resistant to chemicals
- Non-flammable

Use of stainless steel components



Connection of a membrane flange to the parapet



Connection to the adjacent membrane areas.

NEW: Monsoon gravel stop and gravel stop for emergency drainage

The newly developed Monsoon gravel stop is an important contribution to the security of buildings. The special form of this gravel stop more than doubles the drainage performance in ltr/sec compared to any other regular gravel stop. Compatible with all WOLFIN drainage systems.



Monsoon gravel stop

Monsoon gravel stop for emergency drainage

NEW: Parapet Drainage Element

The new Parapet Drainage Element in DN 100 now also enables efficient drainage via the parapet in combination with the Monsoon gravel stop due to its very low installation height. This gives safe and economical drainage of the roof area.

Pipe-length	item-no (black)	item-no (grey)
650 mm	160165	160233
1,000 mm	160168	160237

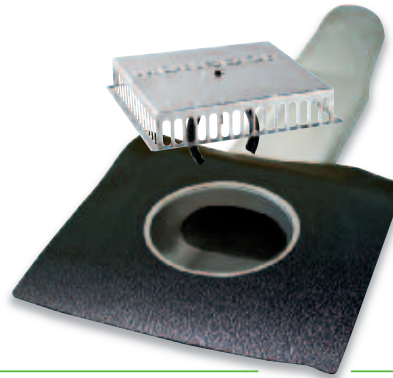

WOLFIN Parapet Drainage Element with Monsoon gravel stop, the new dimension in parapet drainage.

NEW: Damming ring for emergency drainage

With the help of the new WOLFIN stainless steel damming ring for stainless steel drainage systems, every extension element DN 100 can be turned into an emergency drainage element quickly. Simply stick the damming ring into the extension element. Due to the variable insertion positions it is easy to get the needed damming height (25 mm or 35 mm) for emergency drainage.



WOLFIN damming ring for emergency drainage. The safe and quick way from water outlet to emergency drainage.

NEW: Parapet Emergency Drainage Element

The new Attica emergency drainage element in DN 100 has a very low installation height. It comes with 4 different damming rings (25 mm, 30 mm, 35 mm and 40 mm). It is also easy to get excellent drainage results in a horizontal position when it is used in combination with the Monsoon gravel stop for emergency drainage.

Pipe-length	item-no (black)	item-no (grey)
650 mm	160166	160234
1,000 mm	160169	160238

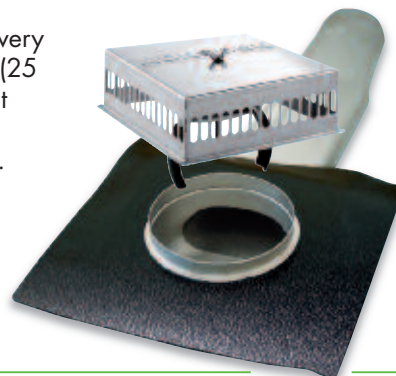

WOLFIN Parapet emergency drainage element with Monsoon gravel stop for emergency drainage. A safe and effective way for horizontal drainage.

DANGER OF CONTACT CORROSION ●

Material	Aluminium	Galvanized	Stainless Steel	Titanium Zinc	Copper	Brass
Aluminium	–	–	–	–	●	●
Galvanized	–	–	–	–	●	●
Stainless Steel	–	–	–	–	–	–
Titanium Zinc	–	–	–	–	●	●
Copper	●	●	–	●	–	–
Brass	●	●	–	●	–	–

Corrosion-proof for maximum security

Stainless steel is compatible with all metals that are commonly used for the construction of buildings. It is not therefore necessary to separate metal combinations, e.g. zinc and copper.

WOLFEN VENTS AND WATER OUTLETS

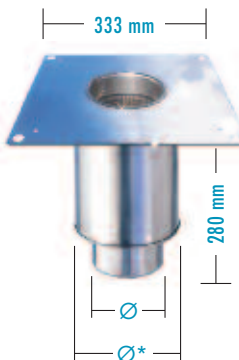
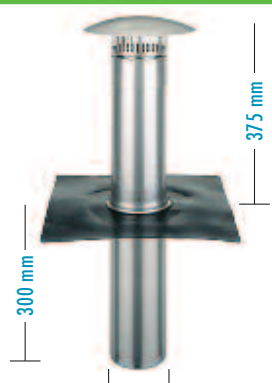
	Basic element Material thickness 1.0 mm, thermally insulated		Ventilation element DN 100 (Ø 110 mm) Vent pipe for sanitary vapour with flange in the middle and with a stainless steel cap
	without insulation: DN 70 Ø 75 mm DN 100 Ø 110 mm DN 125 Ø 125 mm		Material thickness 0.7 mm Pipe-length 300 mm for insulation layers with a thickness of 115 – 230 mm, stainless steel flange (sheet metal) or membrane flange
	with insulation: Ø* 119 mm Ø* 154 mm Ø* 169 mm		

DRAINAGE PERFORMANCE OF WOLFEN ELEMENTS | Vertical (in ltr/sec)

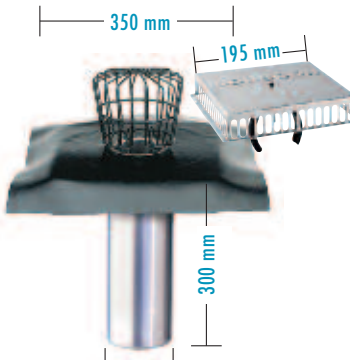
	Extension element DN 70 Ø 75 mm, material thickness 0.7 mm		Renovation element DN 70 Ø 62 mm, with roll ring, material thickness 0.7 mm																																											
	<table border="1"> <thead> <tr> <th>Damming height in mm</th> <th>Standard</th> <th>with Monsoon</th> <th>Standard*</th> <th>with Monsoon</th> <th>Requirement</th> </tr> </thead> <tbody> <tr><td>5</td><td>0.28</td><td>0.35</td><td>0.24</td><td>0.35</td><td></td></tr> <tr><td>15</td><td>1.20</td><td>1.20</td><td>1.01</td><td>0.95</td><td></td></tr> <tr><td>25</td><td>2.39</td><td>3.70</td><td>2.01</td><td>4.10</td><td></td></tr> <tr><td>35</td><td>4.30</td><td>9.60</td><td>3.61</td><td>9.80</td><td>≥ 1.70</td></tr> <tr><td>45</td><td>6.00</td><td>13.85</td><td>5.04</td><td>12.50</td><td></td></tr> <tr><td>55</td><td>–</td><td>13.90</td><td>–</td><td>12.55</td><td></td></tr> </tbody> </table>	Damming height in mm	Standard	with Monsoon	Standard*	with Monsoon	Requirement	5	0.28	0.35	0.24	0.35		15	1.20	1.20	1.01	0.95		25	2.39	3.70	2.01	4.10		35	4.30	9.60	3.61	9.80	≥ 1.70	45	6.00	13.85	5.04	12.50		55	–	13.90	–	12.55				
Damming height in mm	Standard	with Monsoon	Standard*	with Monsoon	Requirement																																									
5	0.28	0.35	0.24	0.35																																										
15	1.20	1.20	1.01	0.95																																										
25	2.39	3.70	2.01	4.10																																										
35	4.30	9.60	3.61	9.80	≥ 1.70																																									
45	6.00	13.85	5.04	12.50																																										
55	–	13.90	–	12.55																																										

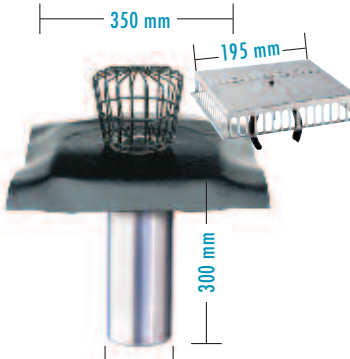
	Extension element DN 100** Ø 110 mm, material thickness 0.7 mm		Renovation element DN 100 Ø 95 mm, with roll ring, material thickness 0.7 mm																																											
	<table border="1"> <thead> <tr> <th>Damming height in mm</th> <th>Standard</th> <th>with Monsoon</th> <th>Standard*</th> <th>with Monsoon</th> <th>Requirement</th> </tr> </thead> <tbody> <tr><td>5</td><td>–</td><td>0.60</td><td>–</td><td>0.50</td><td></td></tr> <tr><td>15</td><td>1.73</td><td>1.95</td><td>1.49</td><td>1.50</td><td></td></tr> <tr><td>25</td><td>3.40</td><td>5.20</td><td>2.94</td><td>4.30</td><td></td></tr> <tr><td>35</td><td>5.61</td><td>11.30</td><td>4.85</td><td>10.50</td><td>≥ 4.50</td></tr> <tr><td>45</td><td>7.78</td><td>19.80</td><td>6.72</td><td>18.70</td><td></td></tr> <tr><td>55</td><td>10.00</td><td>28.00</td><td>8.64</td><td>27.50</td><td></td></tr> </tbody> </table>	Damming height in mm	Standard	with Monsoon	Standard*	with Monsoon	Requirement	5	–	0.60	–	0.50		15	1.73	1.95	1.49	1.50		25	3.40	5.20	2.94	4.30		35	5.61	11.30	4.85	10.50	≥ 4.50	45	7.78	19.80	6.72	18.70		55	10.00	28.00	8.64	27.50				
Damming height in mm	Standard	with Monsoon	Standard*	with Monsoon	Requirement																																									
5	–	0.60	–	0.50																																										
15	1.73	1.95	1.49	1.50																																										
25	3.40	5.20	2.94	4.30																																										
35	5.61	11.30	4.85	10.50	≥ 4.50																																									
45	7.78	19.80	6.72	18.70																																										
55	10.00	28.00	8.64	27.50																																										

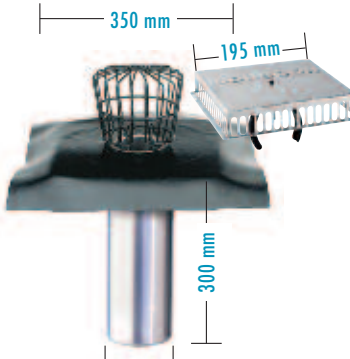
	Extension element DN 125 Ø 125 mm, material thickness 0.7 mm		Renovation element DN 125 Ø 110 mm, with roll ring, material thickness 0.7 mm																																											
	<table border="1"> <thead> <tr> <th>Damming height in mm</th> <th>Standard</th> <th>with Monsoon</th> <th>Standard</th> <th>with Monsoon</th> <th>Requirement</th> </tr> </thead> <tbody> <tr><td>5</td><td>–</td><td>0.60</td><td>–</td><td>0.50</td><td></td></tr> <tr><td>15</td><td>–</td><td>1.95</td><td>1.73</td><td>1.50</td><td></td></tr> <tr><td>25</td><td>3.83</td><td>5.20</td><td>3.40</td><td>4.30</td><td></td></tr> <tr><td>35</td><td>5.80</td><td>11.30</td><td>5.61</td><td>10.50</td><td></td></tr> <tr><td>45</td><td>7.81</td><td>19.80</td><td>7.78</td><td>18.70</td><td>≥ 7.00</td></tr> <tr><td>55</td><td>9.66</td><td>28.00</td><td>10.00</td><td>27.50</td><td></td></tr> </tbody> </table>	Damming height in mm	Standard	with Monsoon	Standard	with Monsoon	Requirement	5	–	0.60	–	0.50		15	–	1.95	1.73	1.50		25	3.83	5.20	3.40	4.30		35	5.80	11.30	5.61	10.50		45	7.81	19.80	7.78	18.70	≥ 7.00	55	9.66	28.00	10.00	27.50				
Damming height in mm	Standard	with Monsoon	Standard	with Monsoon	Requirement																																									
5	–	0.60	–	0.50																																										
15	–	1.95	1.73	1.50																																										
25	3.83	5.20	3.40	4.30																																										
35	5.80	11.30	5.61	10.50																																										
45	7.81	19.80	7.78	18.70	≥ 7.00																																									
55	9.66	28.00	10.00	27.50																																										

Note: Renovation element DN 125 = extension element DN 100

* calculated figures ** also available with grey membrane flange

OUTLET CAPACITY OF WOLFEN DRAINAGE ELEMENTS | Horizontal (in ltr/sec)

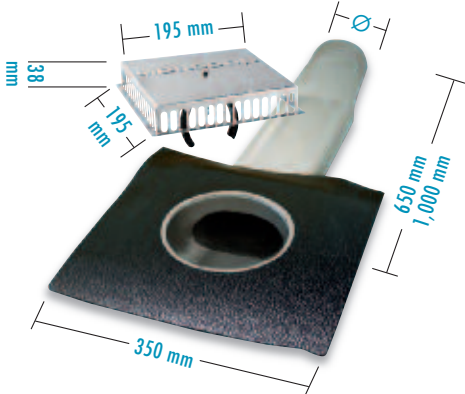

Parapet Drainage Element DN 100** Ø 110 mm, material thickness 1.0 mm, height approx. 144 mm (650 mm) / 232 mm (1,000 mm), with Monsoon gravel stop

Damming height in mm	with Rohr	as reservoir	requirement
5	0.70	0.50	
15	1.80	1.70	
25	3.80	3.40	
35	8.00	6.10	≥ 4.50
45	8.20	7.00	
55	–	7.10	

Rainspout DN 50 Ø 50 mm

Material thickness 0,7 mm, pipe length 500 mm, stainless steel flange and membrane flange

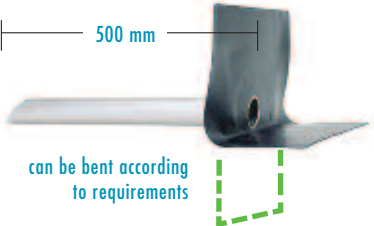

horizontal installation	outlet capacity in ltr/sec Damming height 35 mm
DN 50	0.50
WOLFEN Extension Element (pipe length 300 mm)	
horizontal installation	outlet capacity in ltr/sec Damming height 35 mm
DN 70	0.70
DN 100	1.10

WATER OUTLET CAPACITY FOR EMERGENCY DRAINAGE (in ltr/sec)

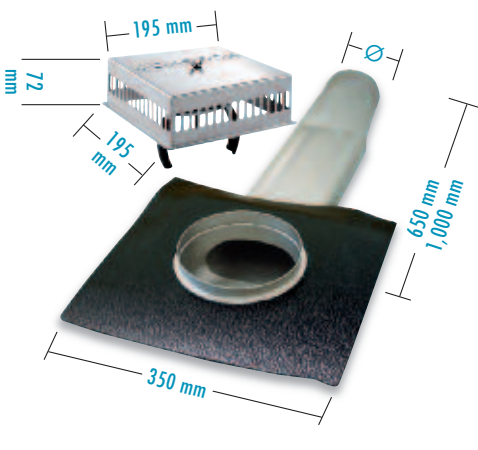

Parapet Emergency Drainage DN 100** Ø 110 mm, material thickness 1.0 mm height appr. 149 mm (650 mm) / 240 mm (1,000 mm), with Monsoon gravel stop for emergency drainage

Damming height in mm	with pipe	as reservoir	requirement
5	0.70	0.70	
15	2.30	2.10	
25	5.30	4.70	
30	10.00	–	
35	15.00	7.50	≥ 4.50
42	21.00	–	
45	–	7.90	

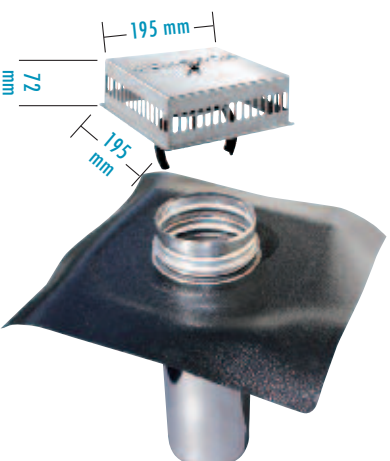

Extension Element DN 100** Ø 110 mm, material thickness 0.7 mm with damming ring and Monsoon gravel stop for emergency drainage

Damming height in mm	Monsoon Emergency Drainage: height of Damming Ring:		requirement
	25 mm	35 mm	
5	0.70	0.80	
10	0.90	1.90	
15	1.50	3.50	
20	2.00	8.10	
25	5.00	13.00	
30	8.60	15.00	
35	13.00	16.00	≥ 4.50
40	15.00	–	
45	16.00	–	

Note: Renovation Element DN 125 = Extension element DN 100

** also available with grey membrane flange

WOLFIN composite metal sheets

Composite metal sheets by WOLFIN are made of 0.6 mm thick, cold-rolled galvanized sheet metal (both sides) that has been laminated with a WOLFIN IB membrane of 0.8 mm thickness in the rolling mill. In addition, the underside of the WOLFIN metal sheets has been stove-enamelled with a coloured protective coating.

Made of stainless steel

If the waterproofing needs to fulfil very high demands, e.g. in commercial kitchens, we recommend using WOLFIN composite metal sheets made of stainless steel.

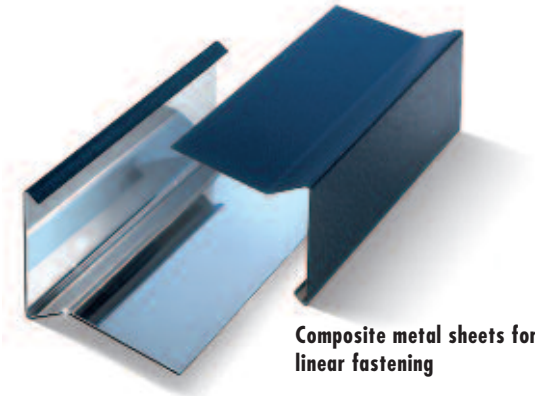

Composite metal sheets for linear fastening

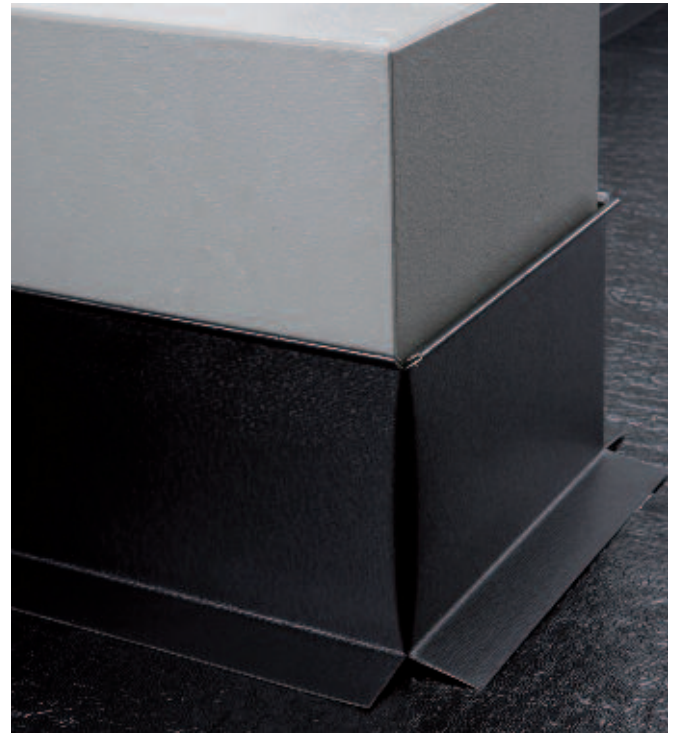

Wall flashing made of composite sheet metal



Verge flashing with outer corner



WOLFIN stainless steel sheets used for connecting rooflights

The most important applications for WOLFIN composite metal sheets and stainless steel

Eaves flashings

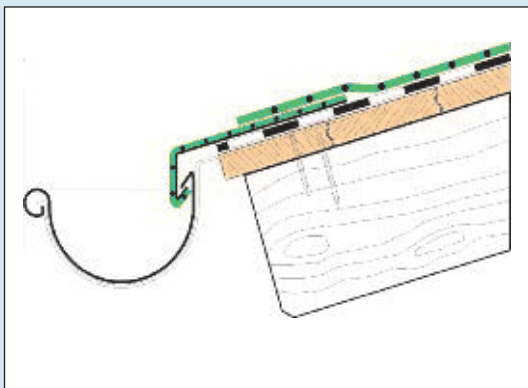

Wall connections, capping strips

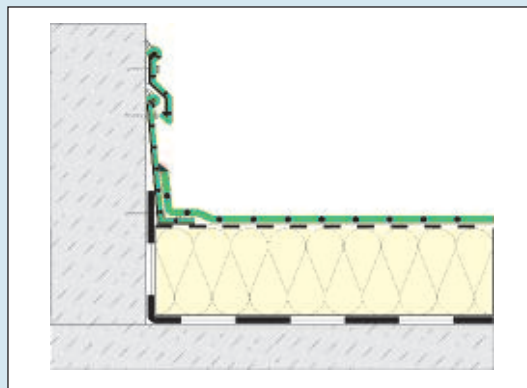

Rooflights, striplights

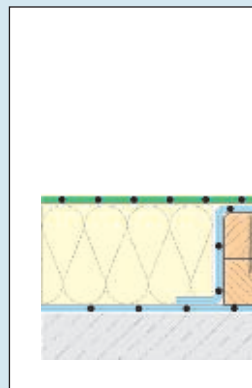

**WOLFIN COMPOSITE SHEETS,
EXAMPLES FOR FABRICATION**

Profile	a	b	c	d	e	f	Typ
Eaves							
	10	100	115	-	-	-	T 10
	10	70	120	-	-	-	T 7
	10	40	115	-	-	-	T 4
Verge/Parapet							
	10	130	35	75	-	-	OG 13
	10	110	35	70	-	-	OG 11
	10	80	35	75	-	-	OG 8
	10	60	25	70	-	-	OG 6
	30	70	-	-	-	-	MAB
Wall connection							
	10	10	190	40	200	-	WA 20
	10	10	140	40	150	-	WA 15
	10	10	50	60	-	-	WA 7
	10	10	30	40	-	-	WA 5
Flashing strip, height 80 mm							
	10	10	25	15	30	10	WA Kapp-leist

**WOLFIN COMPOSITE SHEETS,
EXAMPLES FOR FABRICATION**

Profile	a	b	c	d	e	f	Typ
Connection angle for roof covering							
	30	70	-	-	-	-	DA 3/7
	50	50	-	-	-	-	DA 5

WOLFIN COMPOSITE SHEETS

WOLFIN composite sheet, galvanized, black

Product name	Width mm	Length m	Area m ²
WOLFIN Composite sheet metal	1,000	2	2
WOLFIN Composite sheet metal	1,000	3	3
WOLFIN Composite sheet coil	1,000	30	30

WOLFIN composite sheet, galvanized, grey

Product name	Width mm	Length m	Area m ²
WOLFIN Composite sheet metal	1,000	2	2
WOLFIN Composite sheet coil	1,000	30	30

WOLFIN composite sheet, stainless steel, black

Product name	Width mm	Length m	Area m ²
WOLFIN Composite sheet metal	1,000	2	2

sheets

hts

Edge fastening and parapet flashings

Valley fastening and parapet

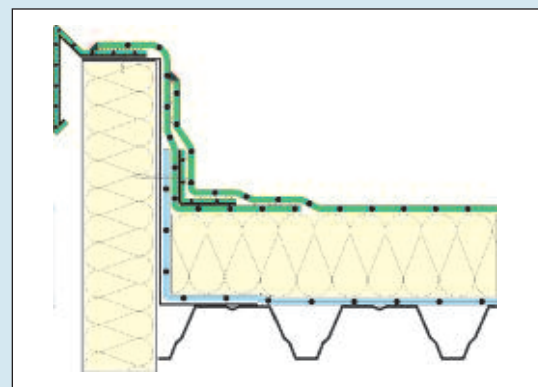
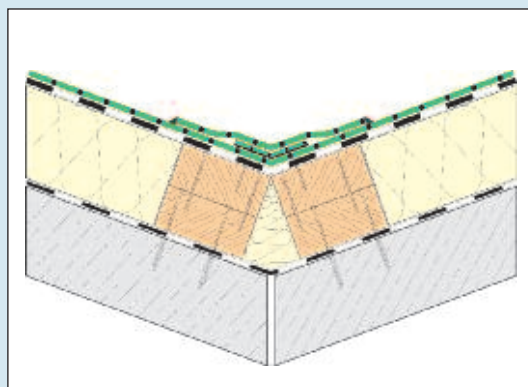
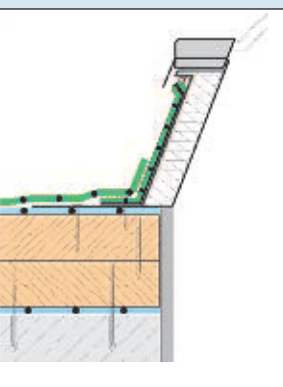



The WITEC Membrane System

The right choice – on all levels

WITEC is an innovative membrane system that allows you to install a nearly complete, multi-layered roof structure. The necessary products are offered as part of a high-quality system so that all layers are perfectly matched. Tested and passed with distinction: the WITEC system by WOLFIN has been tested for wind load resistance according to the UEAtc guideline – even on roof-bearing structures made of wood. The test proved that the layered roof build-up is securely held in place despite the maximum wind force in the wind tunnel.

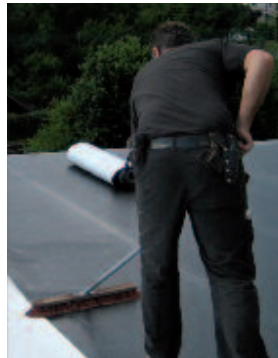

The WITEC SK* and SK* Duo vapour barrier membranes are suitable as primary vapour control layers or as intermediate layers (they are also suitable for emergency water-proofing).

* SK = self-adhesive

The WITEC principle



No open flame required on the roof.

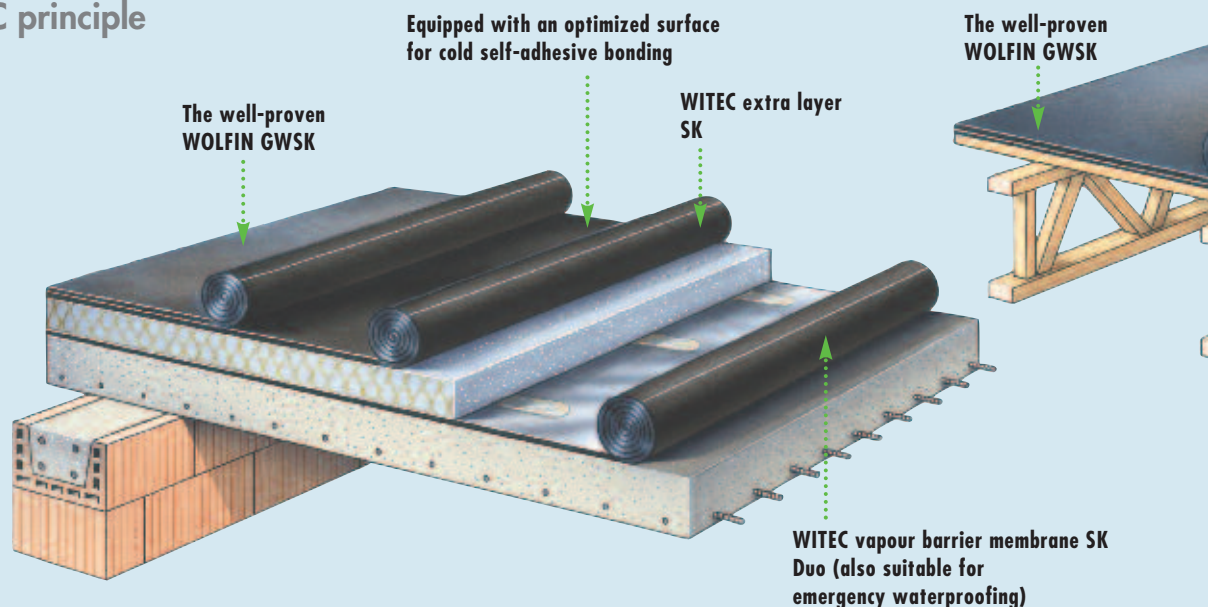

WITEC Vapour Barrier Membrane SK

Special composite membrane made of aluminium-polyester and a cold-bonding self-adhesive layer based on bitumen-rubber. Additionally equipped with a self-adhesive sealing edge and a special surface suitable for fixing insulation materials with a PU adhesive.

S_d-value	approx. 1,500 m
Substrates	Trapezoidal steel sheets*, concrete, precast concrete units, WITEC underlay membrane
Application	Vapour barrier in warm roof constructions

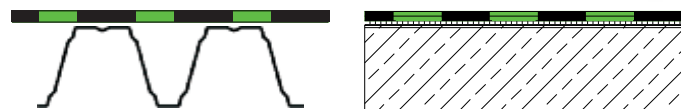

WITEC Vapour Barrier Membrane SK Duo

This membrane is equipped with a second weldable sealing edge and can also be used for emergency waterproofing. The additional sealing edge is fixed by hot air welding or by torch. Thanks to the special surface, insulation materials can be bonded on top with PU adhesives.

S_d-value	approx. 1,500 m
Substrates	Trapezoidal steel sheets*, concrete, precast concrete units, WITEC underlay membrane
Application	Vapour barrier in warm roof constructions, also suitable for emergency waterproofing if the seams are welded (red sealing edge)

* Without primer; in all other cases WOLFIN adhesive base must be applied.

WITEC Extra Layer SK

This extra layer consists of a bitumen-rubber blend and comes equipped with glass fleece reinforcement (120 g/m²), a flat PE film on the upper side and a cold-bonding self-adhesive layer based on bitumen-rubber. The surface has been optimized for cold self-adhesive bonding; however, it is not compatible with PU adhesives.

S_d-value	approx. 54 m
Substrates	Polystyrene insulation, concrete and precast concrete units (with priming coat)
Application	Extra layer that is fixed on polystyrene insulation in the construction of warm roofs, as a levelling course on rough surfaces (e.g. on inverted roofs), for producing fire protection seals. The membrane surface is not compatible with PU adhesives.
Technical data	Width: 1 m · Length: 20 m · Thickness: 1.8 mm Area/roll: 20 m ² · Weight/m ² : 1.7 kg

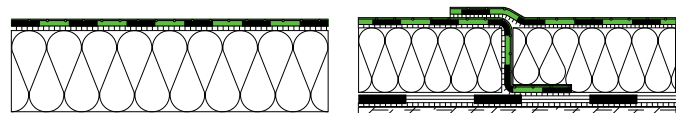

WITEC Underlay Membrane

This underlay membrane consists of a bitumen-rubber blend and comes equipped with a glass fabric reinforcement (200 g/m²) and a flat PE film on both upper and underside. The surface has been optimized for cold self-adhesive bonding (not compatible with PU adhesives). The underlay can be fixed by nails and has a self adhesive sealing edge along its length.

S_d-value	approx. 54 m
Substrates	Wooden materials, concrete, precast concrete units
Application	Underlay membrane used on wooden materials for the direct fixing of cold-bonding self-adhesive membranes in ventilated, multi-layered roof structures. Used as a levelling course on the timber shell of warm roofs to prepare direct bonding of the WITEC vapour barrier membrane SK/SK DUO. As levelling/protection course on rough surfaces. The membrane surface is not compatible with PU adhesives.

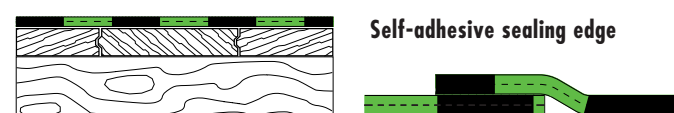

Self-adhesive sealing edge

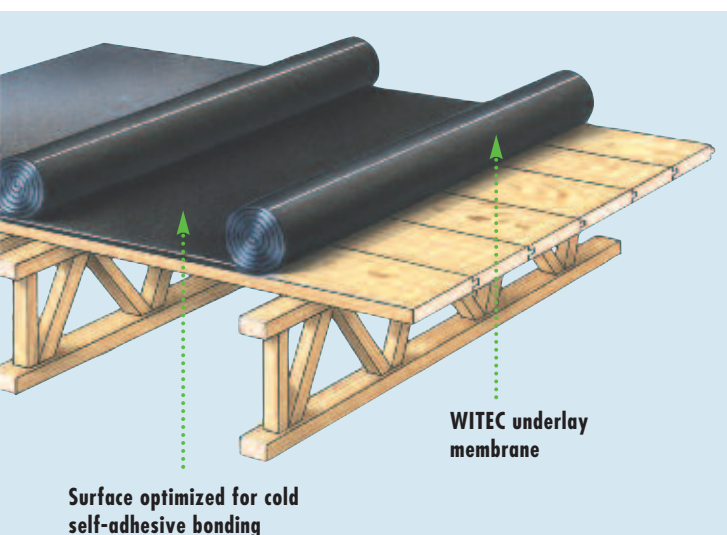

WITEC underlay membrane

WITEC – VAPOUR BARRIER MEMBRANE, EXTRA LAYER AND UNDERLAY MEMBRANE

Product name	Thickness mm	Width mm	Length m	Area m ²	Weight m ²
WITEC Vapour Barrier Membrane SK	1.50	1,100	20	20.00	1.2 kg
WITEC Vapour Barrier Membrane SK Duo	1.50	1,080	15	16.20	1.2 kg
WITEC Extra Layer SK	1.80	1,000	20	20.00	1.7 kg
WITEC Underlay membrane	1.80	1,000	20	20.00	1.7 kg

SK = self-adhesive



Wolfin Flex has the European technical approval

WOLFIN Flex

The liquid for forming and finishing details

WOLFIN Flex is a liquid plastic waterproofing system. Its strength lies in its ability to form details quickly and easily and with its ability to seal small and complex areas. The advantage of WOLFIN Flex is its quick and easy connection of openings or penetrations or constructional systems to those areas that are covered with membranes. It is simple to integrate complicated structures such as metal columns or double t-beams with the help of WOLFIN Flex.

WOLFIN Flex is a one-component, solvent-free liquid sealant that is optimized for all WOLFIN roofing and

waterproofing membranes. This guarantees a safe and long-term bonding.

WOLFIN Flex – features and benefits

- Ozone and UV resistant
- ecologically friendly (without solvents)
- open to diffusion μ 2570
- resistant to root-stock penetration acc. to FLL tests
- safe to use due to the bi-coloured system (green and anthracite)
- no need to mix – ready-made components

The distinctive colours make WOLFIN Flex easy to use and risk-free

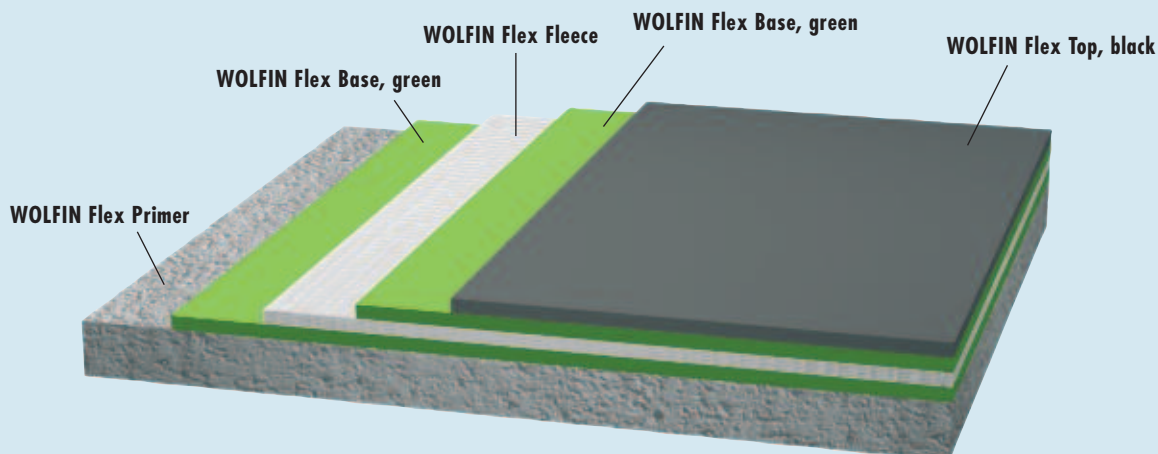

WOLFIN Flex – the adhesive for different surfaces

- Bitumen membranes
- Concrete
- Aluminium
- Ceramics
- Wood
- Glass
- Polystyrene
- Polyurethane

PRODUCT PROPERTIES OF WOLFIN FLEX			
Properties	Test Method/ Test Conditions acc. to DIN		WOLFIN Flex
Elongation (fleece-backed)	DIN 53445	lengthwise crosswise	> 18 % > 22 %
Elongation at -20 °C (fleece backed)	DIN 53445	lengthwise crosswise	> 18 % > 22 %
Tensile strength	DIN 53445	lengthwise crosswise	> 9 N/mm ² > 13 N/mm ²
Tensile Strength at -20 °C	DIN 53445	lengthwise crosswise	> 17.5 N/mm ² > 21.5 N/mm ²
Max. tensile force	DIN 53445	lengthwise crosswise	> 140 N/mm ² > 220 N/mm ²
Crack bridging properties	DIN 485	free from tears and cracks	
Water vapour diffusion resistance	DIN 53122 / DIN EN 1062-2		ca. 2,570
Reaction to water pressure, test pressure 6 bar/24 hrs.	DIN 16726		Tight
Weather resistance	DIN 53387/ISO 11507		Yes
Performance after storage in aqueous solution	DIN 16726		resistant to chemical stress
Performance after storage on bitumen	DIN 16726, 5.19		Bitumen compatible
Dimensional change after warm storage	DIN 16726	lengthwise crosswise	> 18 % > 22 %
Adhesive strength force	DIN EN 1607 DIN ISO 4624	Concrete Softwood Steel Sheet Alum. Sheet	>1.30 N/mm ² >1.50 N/mm ² >1.50 N/mm ² >1.40 N/mm ²
Construction material class	DIN 4102, Part 1		B2
Root Resistance	DIN 4062		Yes

WOLFIN FLEX PRODUCTS

System components

WOLFIN Flex Primer

WOLFIN Flex Base

WOLFIN Flex Top

WOLFIN Flex Accelerator

WOLFIN Flex Fleece
30 cm x 100 m, 100 cm x 100 m (Width x Length)



Easy to use and very economical

WOLFIN Flex is quick and easy to use and it is very economical. The liquid sealant can be applied directly without having to mix it and of course without loss of material. All tools can simply be cleaned with water. Remaining sealant can be used within a certain period of time.

When using the WOLFIN Flex system you have to clean the surface first and treat it with WOLFIN Flex Primer. The first layer is the still wet WOLFIN Flex Base in which the fabric is inserted. Immediately follow again with WOLFIN Flex Base. It is applied wet in wet and generously.

When the surface with the WOLFIN Flex Base (green) has dried, add WOLFIN Flex TOP (anthracite) and apply it generously with a soft brush or paint roller. By doing so you get a durable, weather-, ozone and UV-resistant sealant surface.

WOLFIN Flex Basis is rain-tight after only 2 – 3 hours, depending on the weather conditions at hand. WOLFIN Flex Basis and WOLFIN Flex Top can be applied with a broad-brush, a brush or paint roller. For larger areas it is better to use a roofing brush or an airless-airbrush.

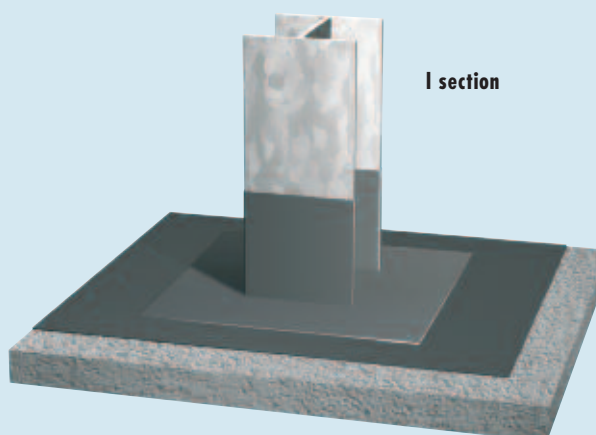
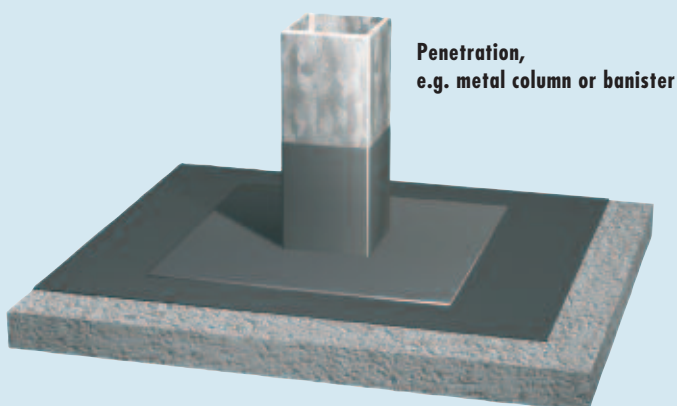



A company of the ICOPAL-Group



WOLFIN Bautechnik GmbH
Am Rosengarten 5
D-63607 Wächtersbach-Neudorf
Tel.: +49 6053 708-0
Fax: +49 6053 708-130
E-Mail: service@wolfin.com

www.wolfin.com



WB10106_1012_VU